

**MOBILE COLUMN LIFTS**  
Electro-hydraulic

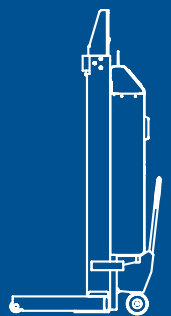

## MOBILE COLUMN LIFTS

Electro-hydraulic



### Innovative features.

Each column has identifying numbering and a LED indicator that shows column operation in real time. All information on the column's state can be checked directly on the App.

### First on the market.

App to set the lift and the layout of the columns.  
The configuration system for columns by App ensures enhanced safety, speed and simplicity in operations.

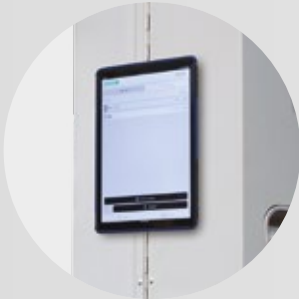

### Totally safe.

Mechanical safety latch system with reduced pitch and increased contact width for greater safety during lifting procedures and to improve parking functions.



**Electro-hydraulic device** that interrupts descent movement if an obstacle is under a platform.

**Extended width** compared to the previous version.



**Safety valves** to protect against overloading and rupture of hydraulic pipes.





**Forklift pockets** to facilitate lifting with forklifts.

**Adjustable forks** to operate on light and heavy commercial vehicles with wheels of different dimensions.



**Hydraulic trolley** for improved column mobility during handling, engagement under the vehicle and parking.



**Compact and solid design.** Powerful hydraulic unit for effortless lifting, paired with all day battery for seamless work.



Lift operation is managed using a **control push-button panel** on each column.

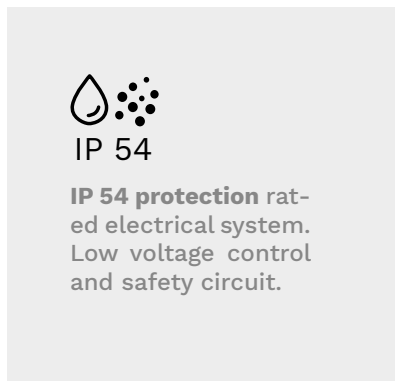

**IP 54**

**IP 54 protection** rated electrical system. Low voltage control and safety circuit.



**Descent speed control valve.**



Configuration of the available columns and creation of separate groups in case the vehicle requires different lift heights.

Software updates over-the-air.



Available for Android and iOS.



## Real-time status.

Mobile column waiting for connection

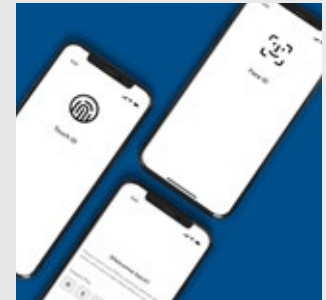

The fast configuration with the App is done via **NFC module**. **Bluetooth** is also integrated as second connection option.

The App user's identity is verified via **biometric authentication** or **OTP** (one time password).

Mobile column showing error



**Simplified troubleshooting.** Identification of column error status and direct link to manual.

Mobile column paired and ready to use



# Accessories



**119777**  
Traverse load capacity 16.4 t



**120260**  
Traverse king pin adapter, load capacity 16.4 t



**122911**  
Front and rear adapters for lifting various tractors and agricultural vehicles, load capacity 16.4 t



**127615**  
Trolley for the tractor adapter set

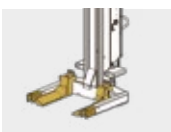

**M75-JCYB-KIT**  
Wheel fork extension for lifting motorhomes, 150 mm, load capacity reduced to 4 t

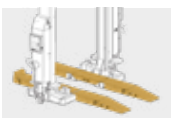

**M140124BG**  
Drive-on ramp kit for forklift trucks, accessible from one side

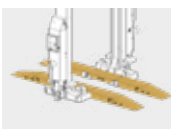

**M140127BG**  
Drive-on ramp kit for forklift trucks, accessible from both sides

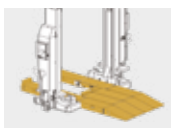

**M140153BG**  
Drive-on ramp kit for three-wheel forklift, accessible from one side



**M110175BG**  
Trolley for drive-on kit for forklift trucks



**S260A1**  
Support Trestle ST-7.5-M (safety stand), load capacity 7.5 t



**S270A1**  
Support Trestle ST-100-M (safety stand), load capacity 10 t



**S270A2**  
Support Trestle ST-100-S (safety stand), load capacity 10 t

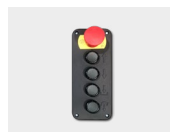

**VSG.MCHYD.903051**  
Mobile electronic control device



**VSG.MCHYD.903082**  
Rainproof protective cover for 6.5 - 7.5 t hydraulic mobile columns



**VSG.MCHYD.903129**  
Rainproof protective cover for 8.5 t hydraulic mobile columns



**VSG.MCHYD.903075**  
LED Lighting kit

# Technical data

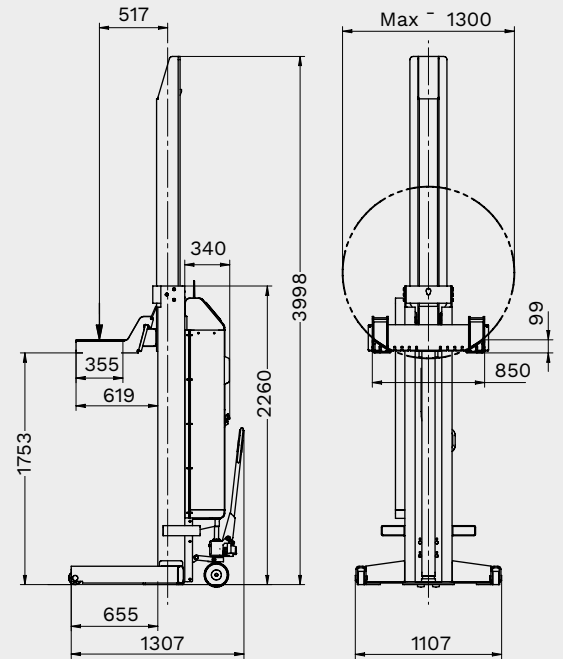

	Alpha 2-6.5	Alpha 4-6.5	Alpha 6-6.5	Alpha 8-6.5	Alpha 2-7.5	Alpha 4-7.5	Alpha 6-7.5	Alpha 8-7.5
	RAV. MCH65.192295	RAV. MCH65.192264	RAV. MCH65.192271	RAV. MCH65.192288	RAV. MCH75.197757	RAV. MCH75.197726	RAV. MCH75.197733	RAV. MCH75.197740
<b>Capacity</b>	13000 kg	26000 kg	39000 kg	52000 kg	15000 kg	30000 kg	45000 kg	60000 kg
<b>Lifting capacity per lifting unit</b>	6500 kg	6500 kg	6500 kg	6500 kg	7500 kg	7500 kg	7500 kg	7500 kg
<b>Communication of columns</b>	wireless							
<b>Number of lifting units</b>	2	4	6	8	2	4	6	8
<b>Stroke</b>	1753 mm							
<b>Lifting time loaded</b>	65 s							
<b>Lowering time loaded</b>	54 s							
<b>Lift cycles fully loaded</b>	14							
<b>Min. wheel diameter</b>	570 mm							
<b>Max. wheel diameter</b>	1300 mm							
<b>Driving power per cylinder unit</b>	3 kW							
<b>Weight per column</b>	640 kg							
<b>Surface coating</b>	powder							
<b>Power supply</b>	230 V   50 - 60 Hz							
<b>Width</b>	1107 mm							
<b>Depth</b>	1307 mm							
<b>Height</b>	2260 mm							
<b>Total weight</b>	1280 kg	2560 kg	3840 kg	5120 kg	1280 kg	2560 kg	3840 kg	5120 kg

	Alpha 2-8.5	Alpha 4-8.5	Alpha 6-8.5	Alpha 8-8.5
	RAV.MCH85.192370	RAV.MCH85.192349	RAV.MCH85.192356	RAV.MCH85.192363
<b>Capacity</b>	17000 kg	34000 kg	51000 kg	68000 kg
<b>Lifting capacity per lifting unit</b>	8500 kg			
<b>Communication of columns</b>	wireless			
<b>Number of lifting units</b>	2	4	6	8
<b>Stroke</b>	1753 mm			
<b>Lifting time loaded</b>	78 s			
<b>Lowering time loaded</b>	54 s			
<b>Lift cycles fully loaded</b>	14			
<b>Min. wheel diameter</b>	570 mm			
<b>Max. wheel diameter</b>	1300 mm			
<b>Driving power per cylinder unit</b>	3 kW			
<b>Weight per column</b>	740 kg			
<b>Surface coating</b>	powder			
<b>Power supply</b>	230 V   50 - 60 Hz			
<b>Width</b>	1167 mm			
<b>Depth</b>	1285 mm			
<b>Height</b>	2590 mm			
<b>Total weight</b>	1480 kg	2960 kg	4440 kg	5920 kg

### RAV Italy

Vehicle Service Group Italy S.r.l.

Via Filippo Brunelleschi 9  
44020 Ostellato (FE)  
Italy

+39.051.6781511  
+39.051.846349  
rav@ravaglioli.com

### RAV France

RAV France SARL

4, Rue De Longue Raie  
ZAC de la Tremblaie  
91220 Le Plessis Pâté  
France

+33.1.60.86.88.16  
+33.1.60.86.82.04  
info.fr@ravaglioli.com

### RAV Germany

BlitzRotary GmbH

Hüfingcr Straße 55  
78199 Bräunlingen  
Germany

+49.771.9233.0  
+49.771.9233.99  
ravd@ravaglioli.com

### RAV UK

Vehicle Service Group UK Ltd

3 Fourth Avenue,  
Bluebridge Industrial Estate  
Halstead, Essex, CO9 2SY  
United Kingdom

+44.1787.477711  
+44.1787.477720  
rav@ravaglioli.com

DRD48 (01)

I dati tecnici e le illustrazioni riportati in questo opuscolo non sono vincolanti. I nostri prodotti sono soggetti a modifiche tecniche, quindi le condizioni di consegna possono variare.

Member of VSG - Vehicle Service Group  
a **DOVER** company

