

# The Perfect Balance between Precision and Practicality

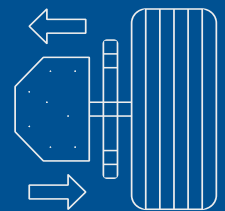

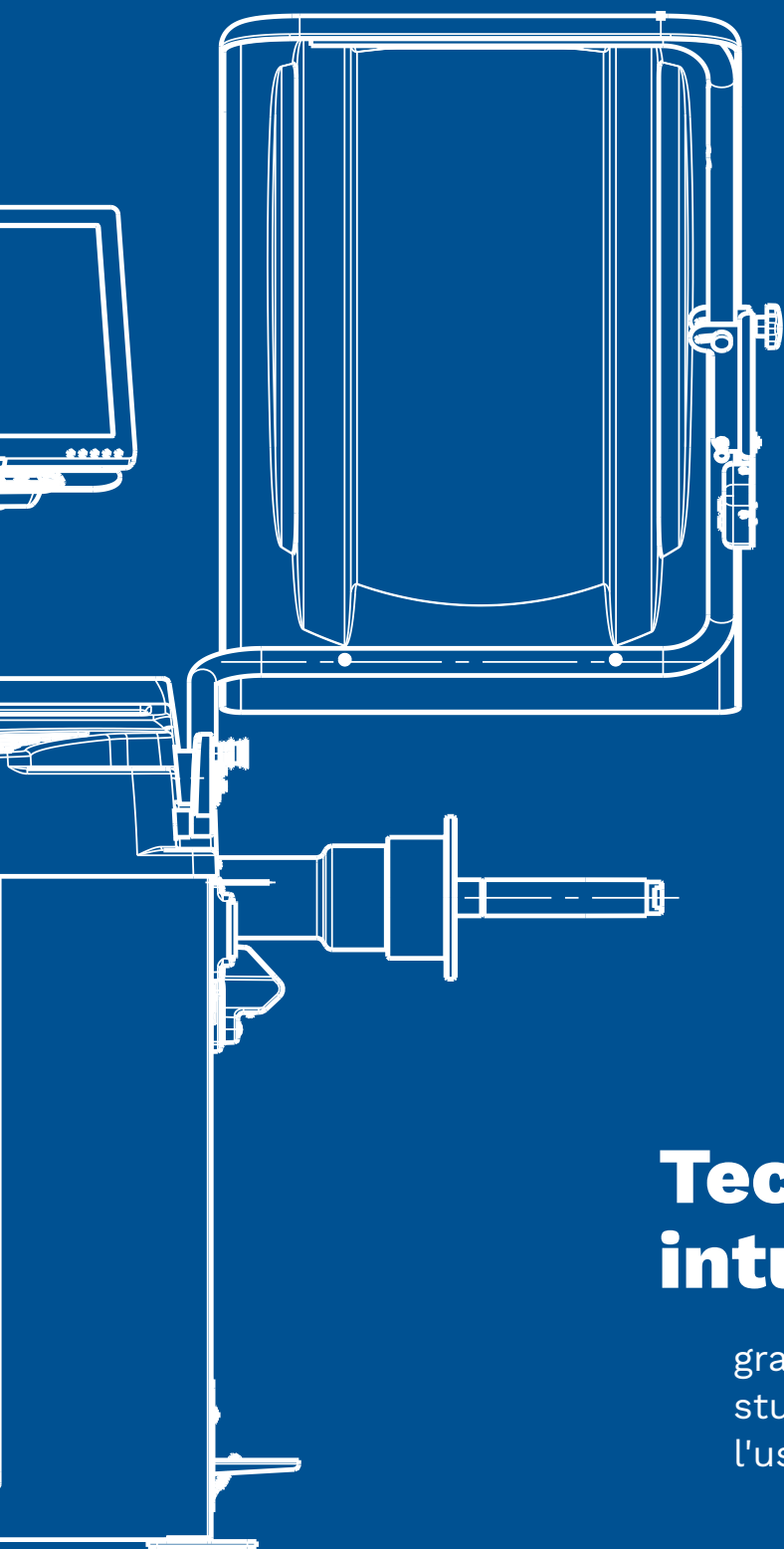

## **Precisione impeccabile:**

acquisizione  
automatica dei dati  
della ruota e puntatore  
a linea laser

## **Design pratico:**

tutto ha il suo  
posto e tutto è al  
posto giusto

## **Tecnologia intuitiva:**

grafica e colori sono  
studiati per agevolare  
l'uso dell'equilibratrice

Equilibratrici elettroniche computerizzate **con arresto automatico della ruota** sia in posizione di squilibrio interno che esterno. Selezione rapida con il calibro distanza e acquisizione automatica della distanza e del diametro.

## EQUILIBRATRICI

Equilibratrici elettroniche computerizzate

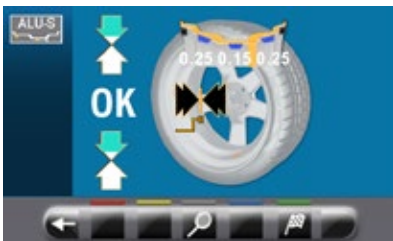
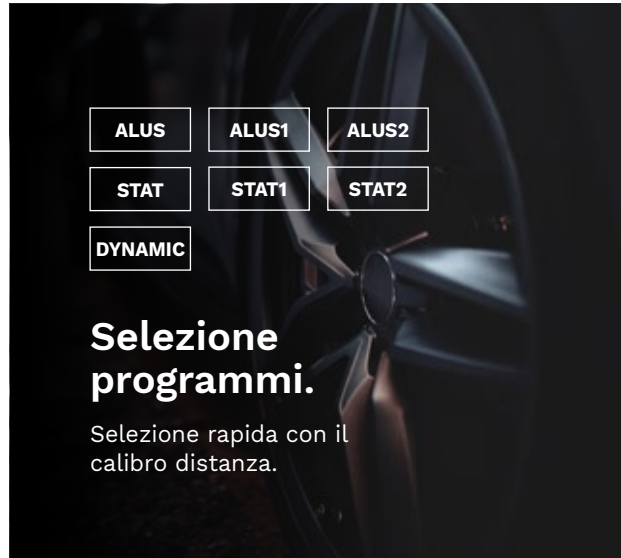



Ottimizzazione dello spazio per rendere tutto pratico e agevole.



Che sia di serie od opzionale, ogni accessorio ha il suo posto.

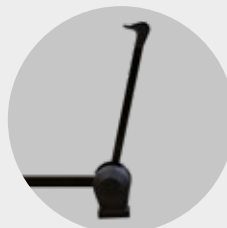

**Calibro larghezza**  
(opzionale per i modelli G3.128NR e G3.150).

**Monitor con touchscreen**  
da 7" e tastiera a membrana.



Modello G3.128NR

**Monitor da 22"**  
e tastiera a membrana.



Modello G3.150WS

Ghiera rapida professionale.

Vaschette di grandi dimensioni per pesi a molletta e adesivi.

Tasca anteriore per riporre gli attrezzi di lavoro.

Acquisizione automatica della larghezza mediante abbassamento della protezione ruota. (Solamente modelli WS)



Grafiche con icone autoesplicative per agevolare l'uso dell'equilibratrice.

Compatibile con il sistema **TEq-Link**  
connected workshop

**INTERNET CONNECTION**  
Invio dei risultati ai clienti.  
Assistenza in remoto.



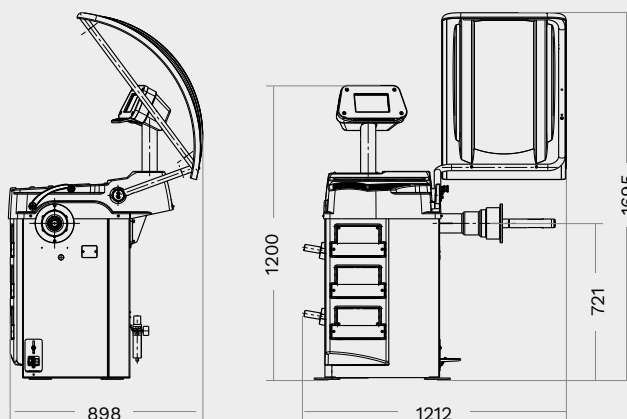



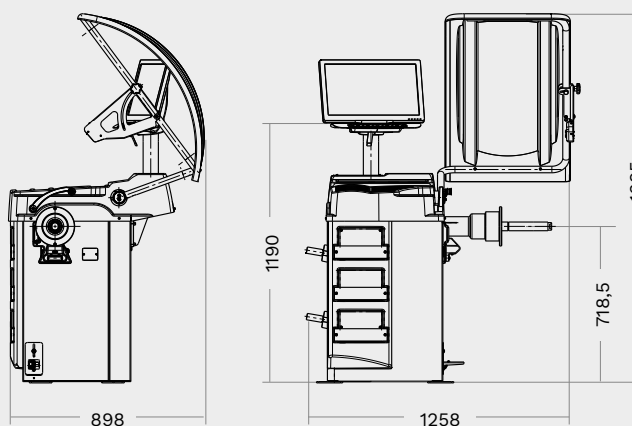





# Dati tecnici

**G3.128NR**

	N. articolo
GP3.150WSPLUS	RAV.G3150.201287
G3.150WSPLUS	RAV.G3150.201331
GP3.150WS	RAV.G3150.201386
G3.150WS	RAV.G3150.201430
GP3.150S	RAV.G3150.201485
G3.150S	RAV.G3150.201539
G3.150	RAV.G3150.201584
GP3.128NR	RAV.G3128.201300
G3.128NR	RAV.G3128.201355

**G3.150**

	G3.128NR Tutti i modelli	G3.150 Tutti i modelli
Diametro min. cerchione	10"	10"
Diametro max. cerchione	26"	26"
Larghezza min. cerchione	1.5"	1.5"
Larghezza max. cerchione	22"	22"
Peso max. ruota	70 kg	70 kg
Precisione equilibratura +/-	1 g	1 g
Tempo medio di lancio	6 s	6 s
Velocità di equilibratura	100 giri/min	100 giri/min
Collegamento elettrico	230V/50-60/1ph	230V/50-60/1ph

		GP3 150WSPLUS	G3 150WSPLUS	GP3 150WS	G3 150WS	GP3 150S	G3 150S	G3 150	GP3 128NR	G3 128NR
	<b>GAR111</b> Coni di centraggio (Ø 44 - 112 mm)	S	S	S	S	S	S	S	S	S
	<b>GAR121</b> Disco protezione	S	S	O	O	O	O	O	O	O
	<b>GAR132</b> Flangia di precisione	S	S	O	O	O	O	O	O	O
	<b>GAR345</b> Doppio centraggio	-	S	-	S	-	S	S	-	S
	<b>GAR351</b> Dispositivi di serraggio	S	-	S	-	S	-	-	S	-
	<b>GAR112</b> Fuoristrada	S	S	O	O	O	O	O	O	O
	<b>GAR306</b> Sensore larghezza	-	-	-	-	S	S	O	O	O
	<b>GAR379</b> Lama laser + luce a LED	S	S	S	S	S	S	O	O	O
	<b>GAR315</b> Sonar Run-out	O	O	-	-	O	O	O*	O*	O*
	<b>GAR377</b> Sonar Run-out	O	O	O	O	-	-	-	-	-
	<b>GAR332</b> Sonar larghezza ruote	S	S	S	S	-	-	-	-	-
	<b>GAR324 - GAR325</b> Sollevatore ruota	O	O	O	O	O	O	O	O	O
	<b>GAR378</b> TEq-Link Software di connettività in officina	O	O	O	O	O	O	O	O	O

\* Necessaria dotazione di GAR306

**S** Standard      **O** Opzionale



#### **RAV Italy**

Vehicle Service Group Italy S.r.l.

Via Filippo Brunelleschi 9  
44020 Ostellato (FE)  
Italy

☎ +39.051.6781511  
☎ +39.051.846349  
✉ rav@ravaglioli.com

#### **RAV France**

RAV France SARL

4, Rue De Longue Raie  
ZAC de la Tremblaie  
91220 Le Plessis Pâté  
France

☎ +331.60.86.88.16  
☎ +331.60.86.82.04  
✉ rav@ravfrance.fr

#### **RAV Germany**

BlitzRotary GmbH

Hüfingener Straße 55  
78199 Bräunlingen  
Germany

☎ +49.771.9233.0  
☎ +49.771.9233.99  
✉ ravid@ravaglioli.com

#### **RAV UK**

Vehicle Service Group UK Ltd

3 Fourth Avenue,  
Bluebridge Industrial Estate  
Halstead, Essex, CO9 2SY  
United Kingdom

☎ +44.1787.477711  
☎ +44.1787.477720  
✉ rav@ravaglioli.com

DRJ19U(02)

I dati tecnici e le illustrazioni riportati in questo opuscolo non sono vincolanti.  
I nostri prodotti sono soggetti a modifiche tecniche, quindi le condizioni di  
consegna possono variare.

Member of VSG - Vehicle Service Group  
a  company

