

2-POST LIFTS
Electromechanical

From History to the Future

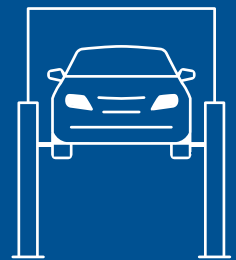

 **Ravaglioli**

LEGEND SERIES
KPX42 - KPX55

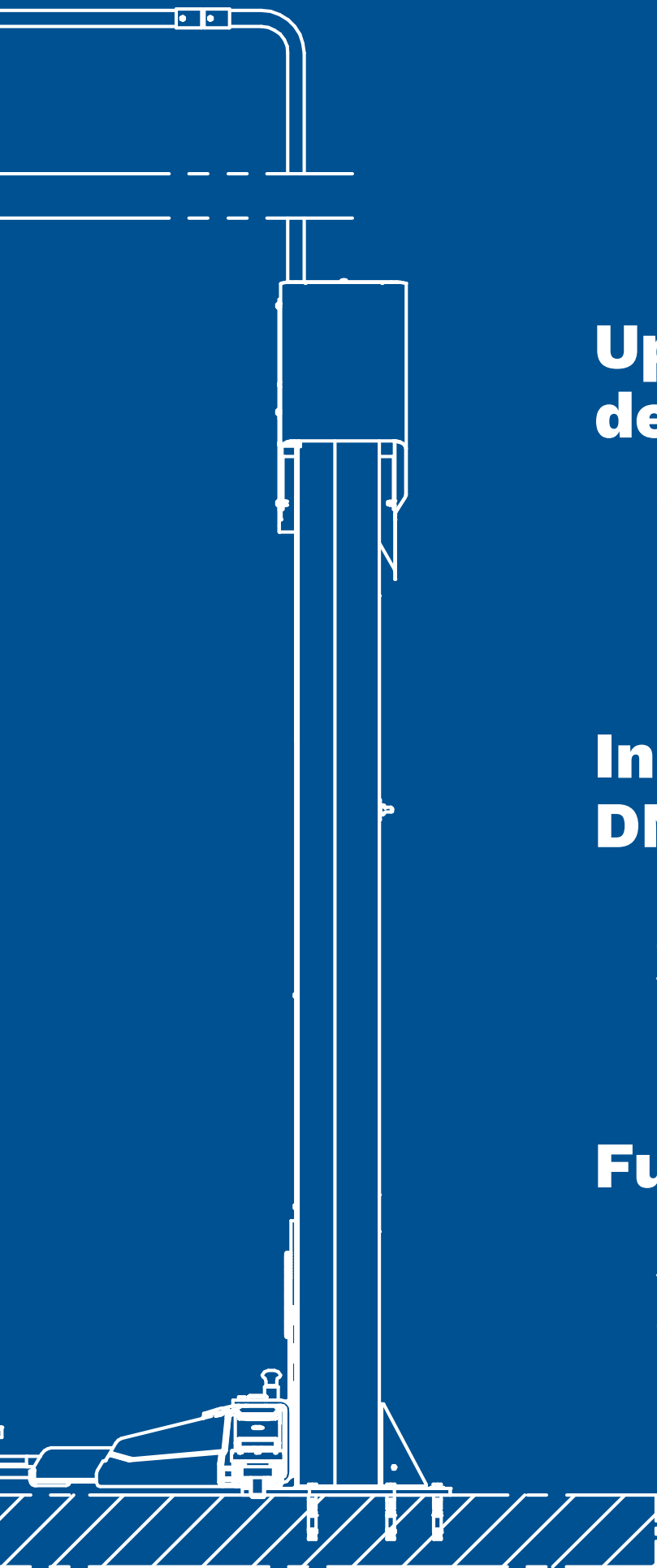

Up-to-date design:

a modern outline that brings modernity and usability to the workshop

Innovative DNA:

long-lasting high-quality components and tested for 20000 cycles

Future proof:

lifts designed for the TEq-Link workshop connectivity system



Emerging from the best selling 2-post lifts, the **Legend Series** consolidates the **engineering knowledge** of Ravaglioli and shapes it into an **innovative package**. **Looking towards the future while always honouring the past**, Ravaglioli has set an important goal for itself - let the performance meet the design.



High efficiency motors.

Automatic conical arm locking system.

Possibility to install without gantry since cables can be placed inground.

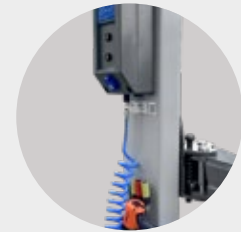

E versions equipped with double control panel and Energy kit.

Automatic and **permanent nut lubrication** system to guarantee efficient movement during lifting and descent.

Steel high resistance **rolled screw** to provide long life.



Equipped with an **acoustic anti toe trap system**. Free from mechanical foot guards.

Premium quality of components.



Aluminum pulley with cooling function.



Long lasting bearings.



50% longer, bronze load nut.

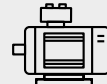

Motors with reinforced and cooling casing.



Solid automatic arm locking.

KPX42E

The arms geometry is designed to lift cars, commercial vehicles and long-wheelbase vans.

Asymmetrical arm configuration (two long and two short arms).

KPX42LIK

Symmetrical arm configuration (four long arms).

Designed for lifting long-wheelbase vans.



4.2

KPX55LIKTA

The arms geometry is designed to lift long-wheelbase commercial vehicles and vans, as well as cars and armoured cars.

Version with two long 3-stage arms and two short 4-stage arms.

5.5



Push buttons control (up/down) at an ergonomic height.



Minimum height of the pads suitable for loading, of armoured cars as well.

Smart and flexible installation.

Up to 20% improvement in installation time. The electronic synchronization avoids the installation and adjustment of the realignment cable. The lifts can be installed in a flexible way thanks to three widthadjustable positions.

More space for movement around the vehicle.

The lift is designed to maximise its layout while ensuring minimum space requirements.



Technical Data

KPX42E
KPX42ELIK-KPX42LIK

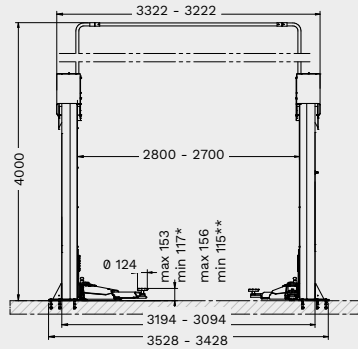

KPX55ELIKTA
KPX55LIKTA

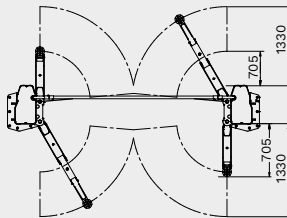
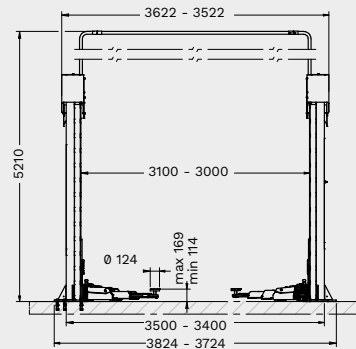

KPX42LIK

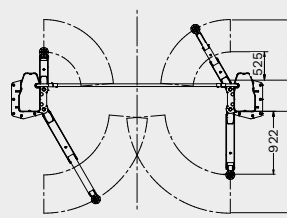

KPX42E

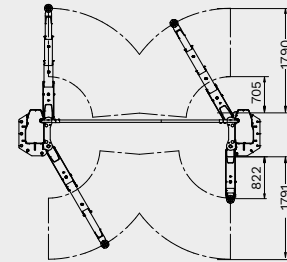

	KPX42E	KPX42LIK	KPX55LIKTA
Capacity	4200 kg	4200 kg	5500 kg
Max. lifting height	2042 mm	2042 mm	2052 mm
Lifting time	58 s	58 s	58 s
Min. pad height	117 mm	115 mm	114 mm
Max. pad height	153 mm	156 mm	169 mm
Column height	2860 mm	2860 mm	3080 mm
Drive-through width	2504 mm	2504 mm	2762 mm
Min. ceiling height	4100 mm	4100 mm	5300 mm
Arm layout	asymmetric	symmetric	asymmetric
Min. front arm length	525 mm	705 mm	705 mm
Max. front arm length	981 mm	1330 mm	1790 mm
Min. rear arm length	922 mm	705 mm	822 mm
Max. rear arm length	1460 mm	1330 mm	1791 mm
Driving power	2x3.5 kW	2x3.5 kW	2x3.5 kW
Width	3428-3528 mm	3428-3528 mm	3724-3824 mm
Height	4000 mm	4000 mm	5210 mm

	Item no.	Double control panel + Energy kit
KPX42E	RAV.KPX42.198303	✓
KPX42LIK	RAV.KPX42.198440	
KPX42ELIK	RAV.KPX42.198488	✓
KPX55LIKTA	RAV.KPX55.198945	
KPX55ELIKTA	RAV.KPX55.198976	✓

TEq-Link
connected workshop

All models of this series are equipped with up/down buttons and TEq-Link connectivity.



RAV Italy

Vehicle Service Group Italy S.r.l.

Via Filippo Brunelleschi 9
44020 Ostellato (FE)
Italy

☎ +39.051.6781511
☎ +39.051.846349
✉ rav@ravaglioli.com

RAV France

RAV France SARL

4, Rue De Longue Raie
ZAC de la Tremblaie
91220 Le Plessis Pâté
France

☎ +331.60.86.88.16
☎ +331.60.86.82.04
✉ rav@ravfrance.fr

RAV Germany

BlitzRotary GmbH

Hüfingener Straße 55
78199 Bräunlingen
Germany

☎ +49.771.9233.0
☎ +49.771.9233.99
✉ ravd@ravaglioli.com

RAV UK

Vehicle Service Group UK Ltd

3 Fourth Avenue,
Bluebridge Industrial Estate
Halstead, Essex, CO9 2SY
United Kingdom

☎ +44.1787.477711
☎ +44.1787.477720
✉ rav@ravaglioli.com

DRD46U(03)

Technical data and composition presented in this catalogue may vary.
Pictures reproduced are only indicative.

Member of VSG - Vehicle Service Group
a **DOVER** company



Accessories



VSG.2CALL.901071
Kit containing 8 spacers for pads
4 spacers x H 89 mm + 4 spacers x
H 127 mm, 2 spacer support brackets



VSG.2CALL.901248
Kit containing 4 spacers for pads
4 spacers x H 200 mm, 2 spacer
support brackets



VSG.2CALL.901163
Kit with frame engaging adapters
1 set with 4 pieces

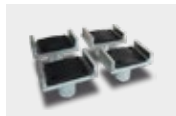

VSG.2CALL.901330
Kit with U-shaped frame engaging
adapters
1 set with 4 pads



VSG.2CALL.901538
Kit with pads for TESLA vehicles
1 set with 4 pads

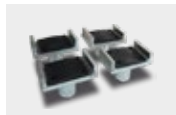

VSG.2CALL.901330
Kit with U-shaped frame engaging
adapters
1 set with 4 pieces



VSG.2CALL.901712
Sprinter/crafter support pads kit
1 set with 6 pads, for Mercedes
Sprinter and Volkswagen Crafter old
and new series



VSG.2CALL.901606
Ducato/boxer/jumper support pads kit
1 set of 4 pads, 2 front and 2 rear



VSG.2CELM.902344
Kit for increasing overhead cable
passage height
Up to + 1.5 m



VSG.2CELM.901927
Eyebolt for handling columns (3.2 t -
3.5 t - 4.2 t)
It facilitates installation of the lift, can
be used again for other installations



VSG.2CELM.902498
Inground cable connection kit
Allows columns connection cables to
be placed inground, eliminating the
overhead connecting pipes and height
restrictions. Ideal for workshops with
low ceilings



VSG.2CELM.902894
Eyebolt for column handling (5.5 t)
It facilitates the handling and
installation of the lift, reusable for
multiple installations



VSG.2CALL.902412
Outrigger plates kit (5.5 t)
Set of 2 plates, allowing installation
on floors with poor capacity or lower
concrete thickness



VSG.2CALL.901453
Outrigger plates kit (4.2/4.5 t)
1 set of 2 plates, allowing installation
on floors with poor capacity or lower
concrete thickness



VSG.2CALL.902818
Vehicles lift platforms kit
1 set with 4 ramps, ramp height 60 mm

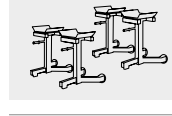

VSG.2CALL.902085
Kit of stands for alignment
1 set with 4 stands



VSG.2CALL.902641
Magnetic tray
1 set with 2 trays



VSG.2CALL.902511
Holder for impact wrench
Ergonomic tool support



VSG.2CELM.903044
Arm extension kit for arms (for LIK/
ELIK models only)
1 pair, load capacity reduced to
3500 kg