

# The Perfect Balance between Precision and Practicality

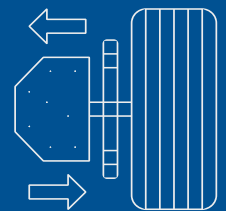

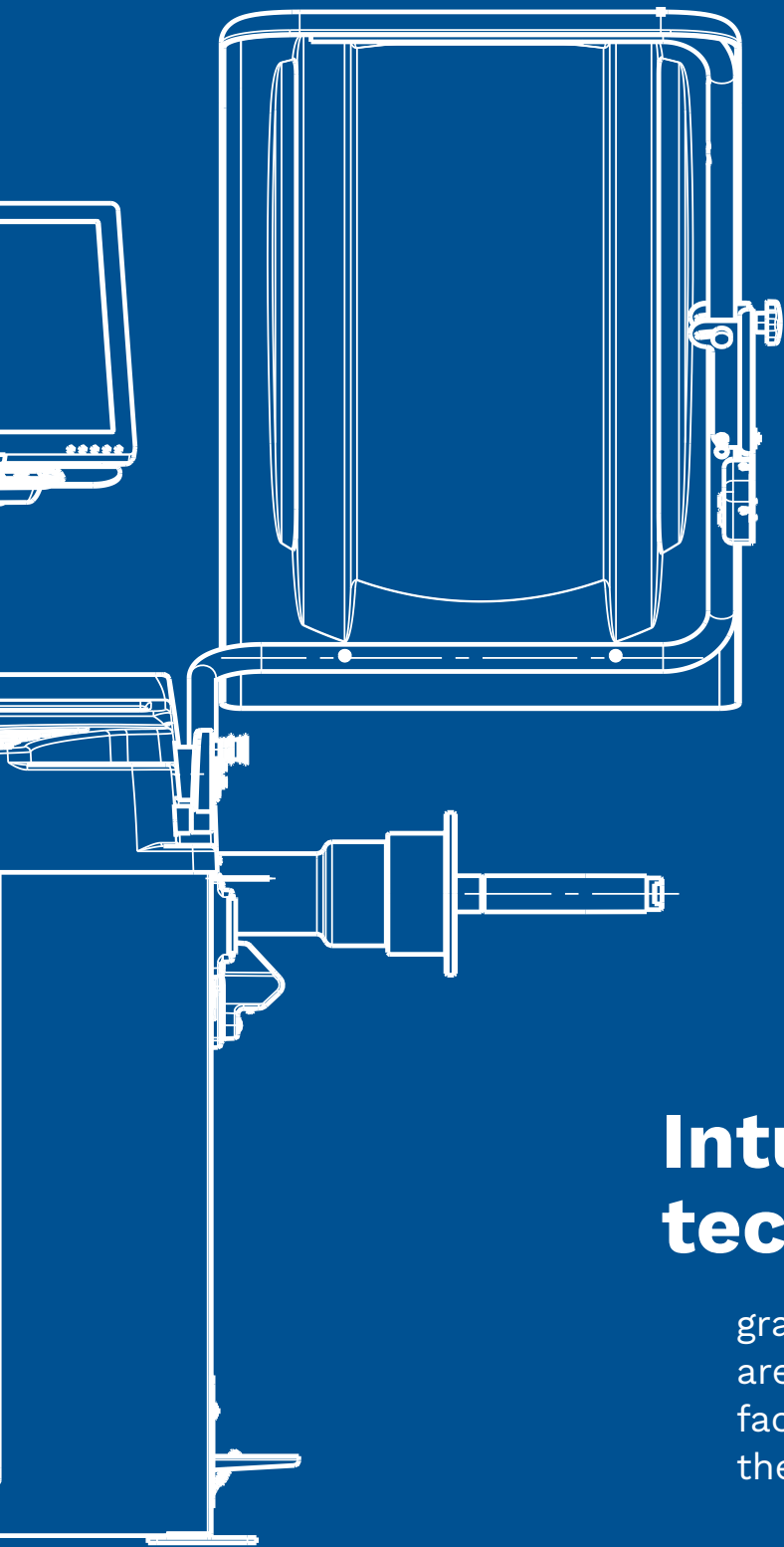

## **Impeccable precision:**

automatic wheel data acquisition and laser blade

## **Practical design:**

everything has a place, everything is in the right spot

## **Intuitive technology:**

graphics and colors are studied to facilitate the use of the wheel balancer



Electronic wheel balancers with microprocessor **with wheel stops automatically** in both outside and inside unbalance position. Quick selection with internal data gauge. Automatic storage of distance and diameter.

## WHEEL BALANCERS

Electronic wheel balancers with microprocessor

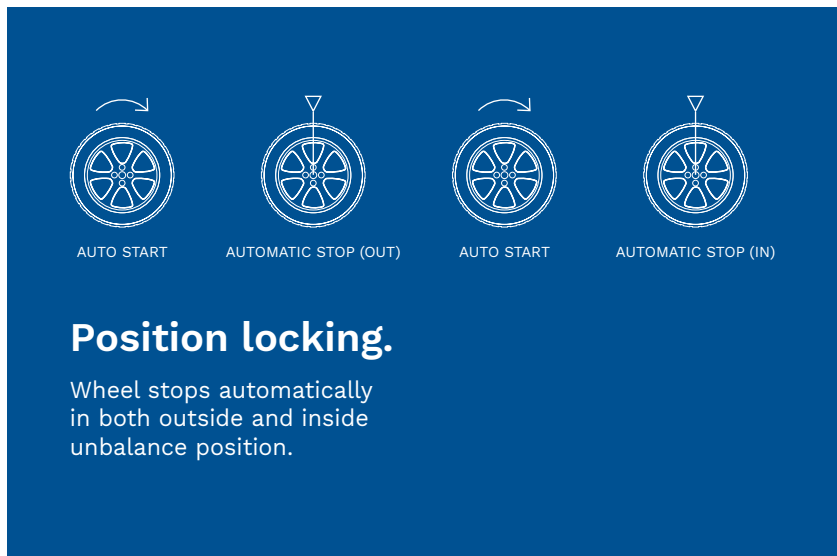
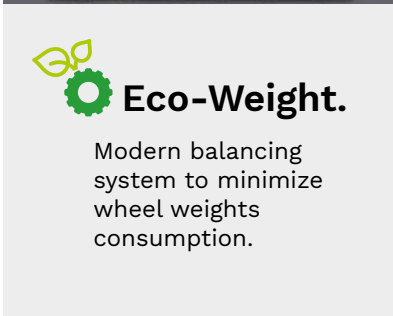
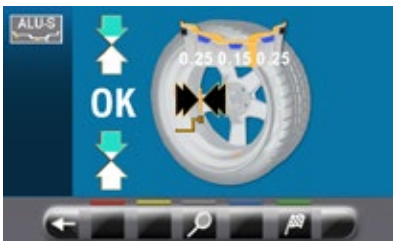
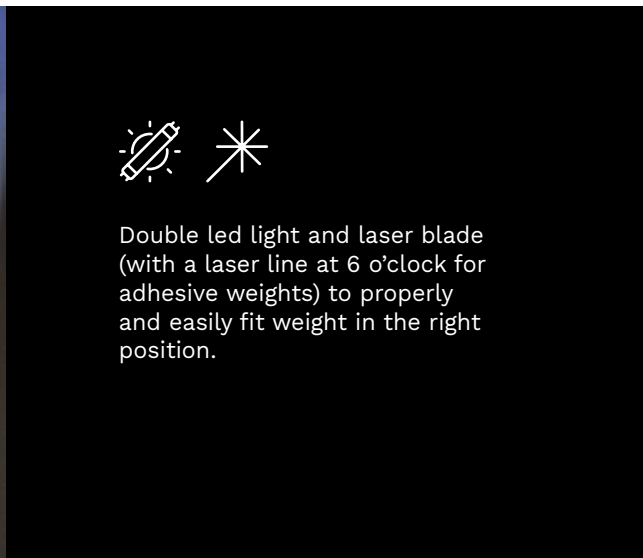
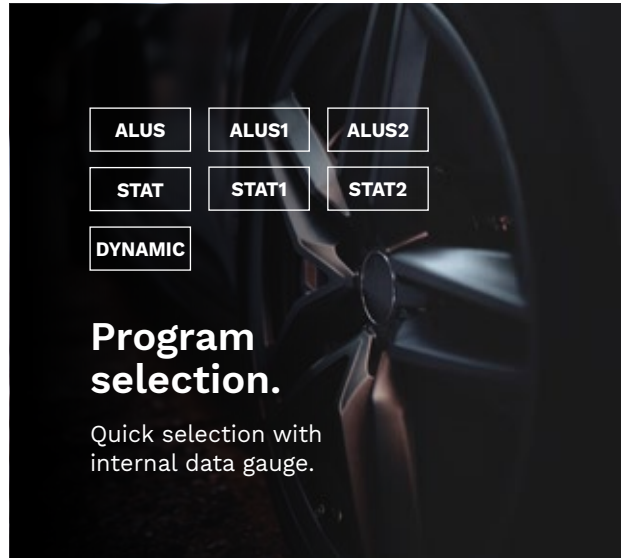



## WHEEL BALANCERS

Electronic wheel balancers with microprocessor



Optimization of the space to make everything handy and easy.



Whether they are standard or optional, every accessory has its own place.

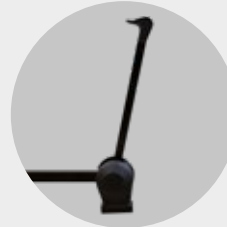

**External data gauge.**  
(Optional for G3.128NR and G3.150 models).

**7" touch screen monitor with foil keyboard.**

**22" monitor with foil keyboard.**



Model G3.128NR

Professional Quick Nut.

Large housing for clip-on and tape weights.

Front pocket to store working tools.



Model G3.150WS

Automatic width acquisition by lowering the wheel guard. (Only for WS models)

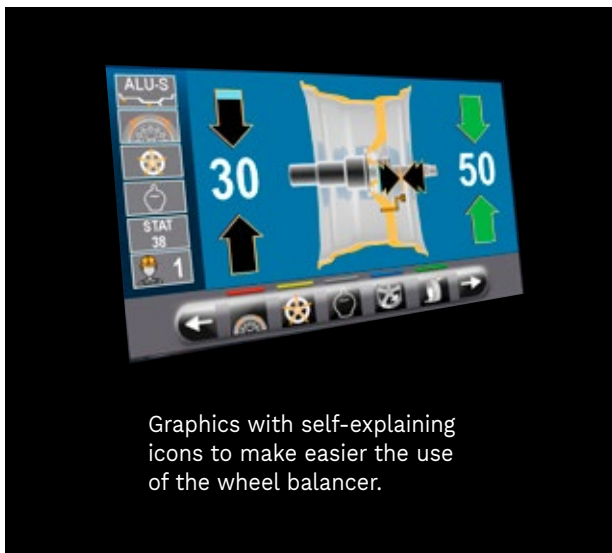

Graphics with self-explaining icons to make easier the use of the wheel balancer.

Compatible with system

**TEQ-Link**  
connected workshop

**INTERNET CONNECTION**  
Sending results to the customers.  
Remote assistance.

## WHEEL BALANCERS

Electronic wheel balancers with microprocessor



# Technical data

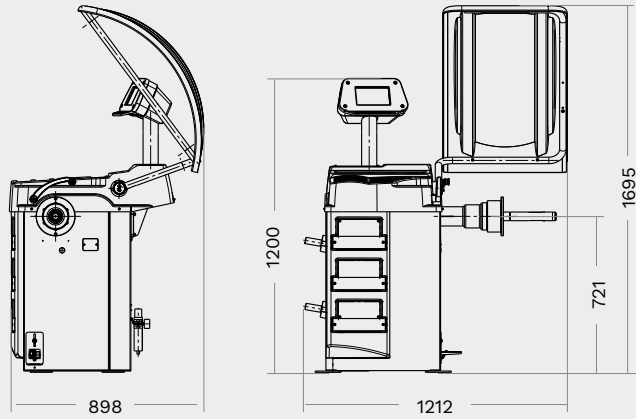





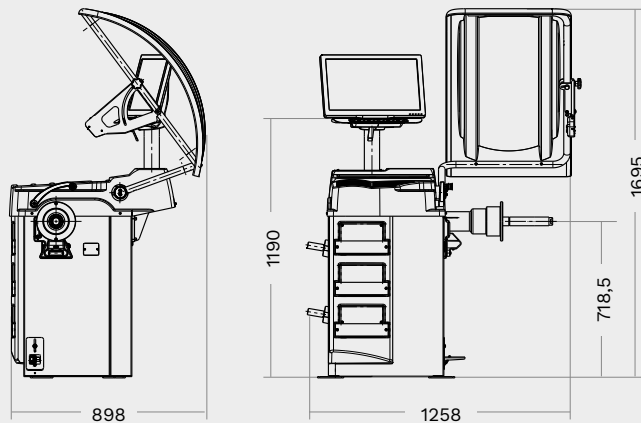









G3.128NR

	Item no.
GP3.150WSPLUS	RAV.G3150.201287
G3.150WSPLUS	RAV.G3150.201331
GP3.150WS	RAV.G3150.201386
G3.150WS	RAV.G3150.201430
GP3.150S	RAV.G3150.201485
G3.150S	RAV.G3150.201539
G3.150	RAV.G3150.201584
GP3.128NR	RAV.G3128.201300
G3.128NR	RAV.G3128.201355



G3.150

	G3.128NR All models	G3.150 All models
Min. rim diameter	10"	10"
Max. rim diameter	26"	26"
Min. rim width	1.5"	1.5"
Max. rim width	22"	22"
Max. wheel weight	70 kg	70 kg
Balancing accuracy +/-	1 g	1 g
Measuring time	6 s	6 s
Measuring speed	100 rpm	100 rpm
Power supply	230V/50-60/1ph	230V/50-60/1ph

	GP3 150WSPLUS	G3 150WSPLUS	GP3 150WS	G3 150WS	GP3 150S	G3 150S	G3 150	GP3 128NR	G3 128NR
 <b>GAR111</b> Passenger car cone set (Ø 44 - 112 mm)	S	S	S	S	S	S	S	S	S
 <b>GAR121</b> Protection disk	S	S	O	O	O	O	O	O	O
 <b>GAR132</b> Precision flange	S	S	O	O	O	O	O	O	O
 Wheel width measuring gauge (manual)	S	S	O	O	O	O	O	O	O
 <b>GAR345</b> Quick nut	S	S	-	S	-	S	S	-	S
 <b>GAR351</b> Locking hub	S	S	S	-	S	-	-	S	-
 <b>GAR112</b> Centering cone	S	S	O	O	O	O	O	O	O
 <b>GAR306</b> Wheel width gauge	O	O	-	-	S	S	O	O	O
 <b>GAR379</b> laser blade + LED light	S	S	S	S	S	S	S	S	S
 <b>GAR315</b> Run-out sonar	O	O	-	-	O	O	-	O	O
 <b>GAR377</b> Run-out sonar	O	O	O	O	-	-	-	-	-
 <b>GAR332</b> Wheel width sonar	O	O	S	S	-	-	-	-	-
 <b>GAR324 - GAR325</b> Wheel lift	O	O	O	O	O	O	O	O	O
 <b>GAR358</b> Workshop connectivity software TEq-Link	O	O	O	O	O	O	O	O	O

**S** Standard      **O** Optional



### **RAV Italy**

Vehicle Service Group Italy S.r.l.

Via Filippo Brunelleschi 9  
44020 Ostellato (FE)  
Italy

☎ +39.051.6781511  
☎ +39.051.846349  
✉ rav@ravaglioli.com

### **RAV France**

RAV France SARL

4, Rue De Longue Raie  
ZAC de la Tremblaie  
91220 Le Plessis Pâté  
France

☎ +331.60.86.88.16  
☎ +331.60.86.82.04  
✉ rav@ravfrance.fr

### **RAV Germany**

BlitzRotary GmbH

Hüfingener Straße 55  
78199 Bräunlingen  
Germany

☎ +49.771.9233.0  
☎ +49.771.9233.99  
✉ ravid@ravaglioli.com

### **RAV UK**

Vehicle Service Group UK Ltd

3 Fourth Avenue,  
Bluebridge Industrial Estate  
Halstead, Essex, CO9 2SY  
United Kingdom

☎ +44.1787.477711  
☎ +44.1787.477720  
✉ rav@ravaglioli.com

DRJ19U(02)

Technical data and composition presented in this catalogue may vary.  
Pictures reproduced are only indicative.

Member of VSG - Vehicle Service Group  
a  company

