

The Perfect Balance between Precision and Practicality

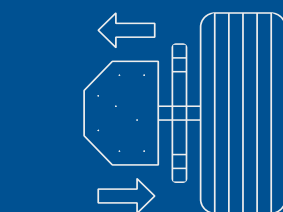

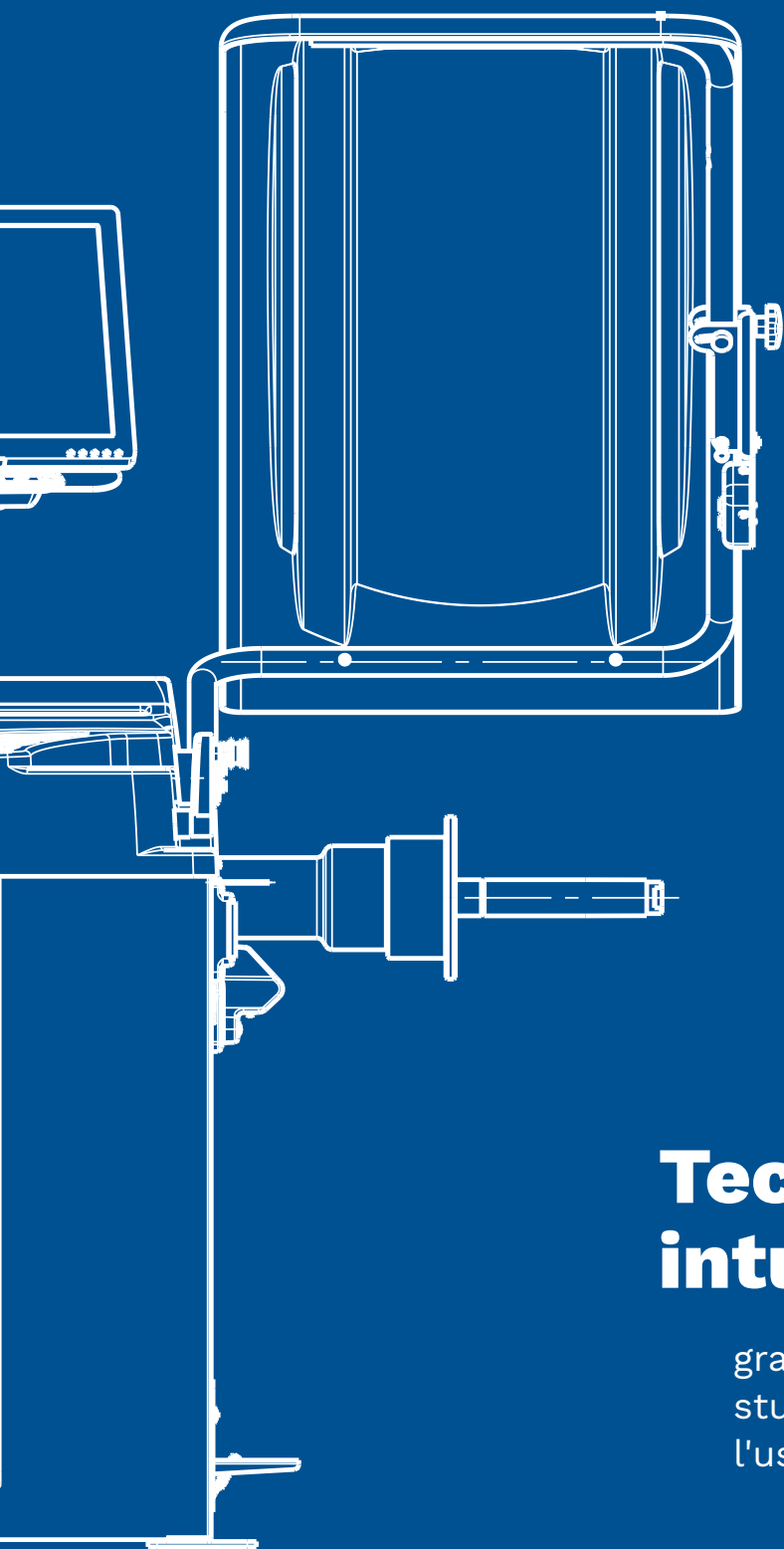

Precisione impeccabile:

acquisizione
automatica dei dati
della ruota e puntatore
a linea laser

Design pratico:

tutto ha il suo
posto e tutto è al
posto giusto

Tecnologia intuitiva:

grafica e colori sono
studiati per agevolare
l'uso dell'equilibratrice

Equilibratrici elettroniche computerizzate con arresto automatico della ruota sia in posizione di squilibrio interno che esterno. Selezione rapida con il calibro distanza e acquisizione automatica della distanza e del diametro.

EQUILIBRATRICI

Equilibratrici elettroniche computerizzate

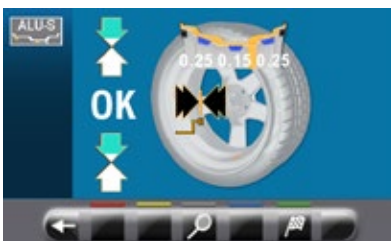
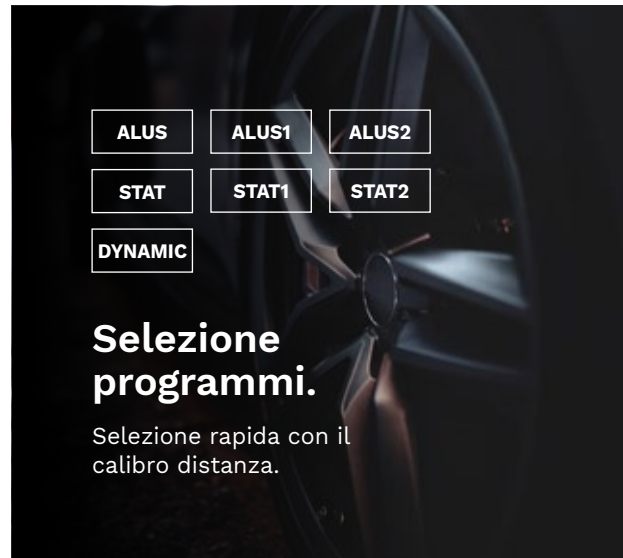



Ottimizzazione dello spazio per rendere tutto pratico e agevole.



Che sia di serie od opzionale, ogni accessorio ha il suo posto.

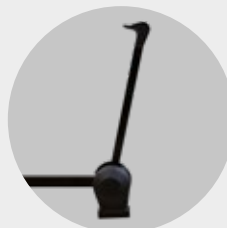

Calibro larghezza
(opzionale per i modelli G3.128NR e G3.150).

Monitor con touchscreen
da 7" e tastiera a membrana.



Modello G3.128NR

Monitor da 22"
e tastiera a membrana.



Modello G3.150WS

Ghiera rapida professionale.

Vaschette di grandi dimensioni per pesi a molletta e adesivi.

Tasca anteriore per riporre gli attrezzi di lavoro.

Acquisizione automatica della larghezza mediante abbassamento della protezione ruota. (Solamente modelli WS)



Grafiche con icone autoesplicative per agevolare l'uso dell'equilibratrice.

Compatibile con il sistema

TEq-Link

connected workshop

INTERNET CONNECTION

Invio dei risultati ai clienti.
Assistenza in remoto.



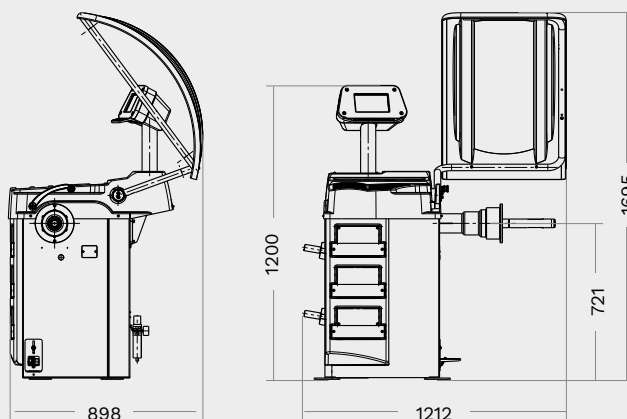



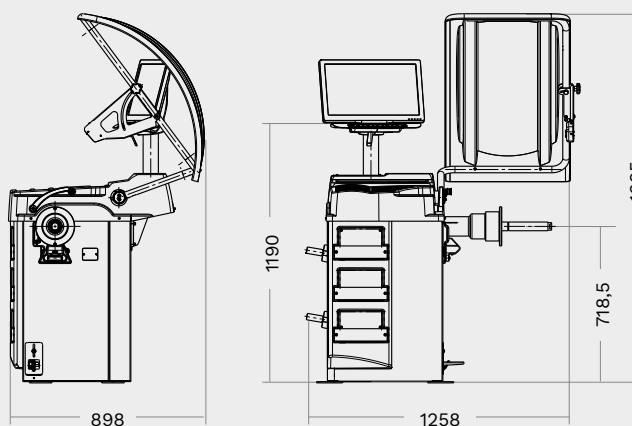







Dati tecnici

G3.128NR

	N. articolo
GP3.150WSPLUS	RAV.G3150.201287
G3.150WSPLUS	RAV.G3150.201331
GP3.150WS	RAV.G3150.201386
G3.150WS	RAV.G3150.201430
GP3.150S	RAV.G3150.201485
G3.150S	RAV.G3150.201539
G3.150	RAV.G3150.201584
GP3.128NR	RAV.G3128.201300
G3.128NR	RAV.G3128.201355

G3.150

	G3.128NR Tutti i modelli	G3.150 Tutti i modelli
Diametro min. cerchione	10"	10"
Diametro max. cerchione	26"	26"
Larghezza min. cerchione	1.5"	1.5"
Larghezza max. cerchione	22"	22"
Peso max. ruota	70 kg	70 kg
Precisione equilibratura +/-	1 g	1 g
Tempo medio di lancio	6 s	6 s
Velocità di equilibratura	100 giri/min	100 giri/min
Collegamento elettrico	230V/50-60/1ph	230V/50-60/1ph

		GP3 150WSPLUS	G3 150WSPLUS	GP3 150WS	G3 150WS	GP3 150S	G3 150S	G3 150	GP3 128NR	G3 128NR
	GAR111 Coni di centraggio (Ø 44 - 112 mm)	S	S	S	S	S	S	S	S	S
	GAR121 Disco protezione	S	S	O	O	O	O	O	O	O
	GAR132 Flangia di precisione	S	S	O	O	O	O	O	O	O
	Calibro manuale larghezza	S	S	O	O	O	O	O	O	O
	GAR345 Doppio centraggio	S	S	-	S	-	S	S	-	S
	GAR351 Dispositivi di serraggio	S	S	S	-	S	-	-	S	-
	GAR112 Fuoristrada	S	S	O	O	O	O	O	O	O
	GAR306 Sensore larghezza	O	O	-	-	S	S	O	O	O
	GAR379 Lama laser + luce a LED	S	S	S	S	S	S	S	S	S
	GAR315 Sonar Run-out	O	O	-	-	O	O	-	O	O
	GAR377 Sonar Run-out	O	O	O	O	-	-	-	-	-
	GAR332 Sonar larghezza ruote	O	O	S	S	-	-	-	-	-
	GAR324 - GAR325 Sollevatore ruota	O	O	O	O	O	O	O	O	O
	GAR358 Teq-Link Software di connettività in officina	O	O	O	O	O	O	O	O	O

S Standard **O** Opzionale



RAV Italy

Vehicle Service Group Italy S.r.l.

Via Filippo Brunelleschi 9
44020 Ostellato (FE)
Italy

☎ +39.051.6781511
☎ +39.051.846349
✉ rav@ravaglioli.com

RAV France

RAV France SARL

4, Rue De Longue Raie
ZAC de la Tremblaie
91220 Le Plessis Pâté
France

☎ +331.60.86.88.16
☎ +331.60.86.82.04
✉ rav@ravfrance.fr

RAV Germany

BlitzRotary GmbH

Hüfingener Straße 55
78199 Bräunlingen
Germany

☎ +49.771.9233.0
☎ +49.771.9233.99
✉ ravid@ravaglioli.com

RAV UK

Vehicle Service Group UK Ltd

3 Fourth Avenue,
Bluebridge Industrial Estate
Halstead, Essex, CO9 2SY
United Kingdom

☎ +44.1787.477711
☎ +44.1787.477720
✉ rav@ravaglioli.com

DRJ19U(02)

I dati tecnici e le illustrazioni riportati in questo opuscolo non sono vincolanti.
I nostri prodotti sono soggetti a modifiche tecniche, quindi le condizioni di
consegna possono variare.

Member of VSG - Vehicle Service Group
a  company

