

EQUILIBREUSES

Equilibreuses électroniques a microprocesseur

The Perfect Balance between Precision and Practicality

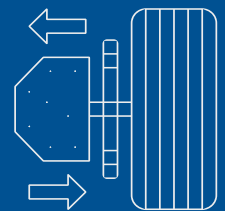

 **Ravaglioli**

G3.150
G3.128NR

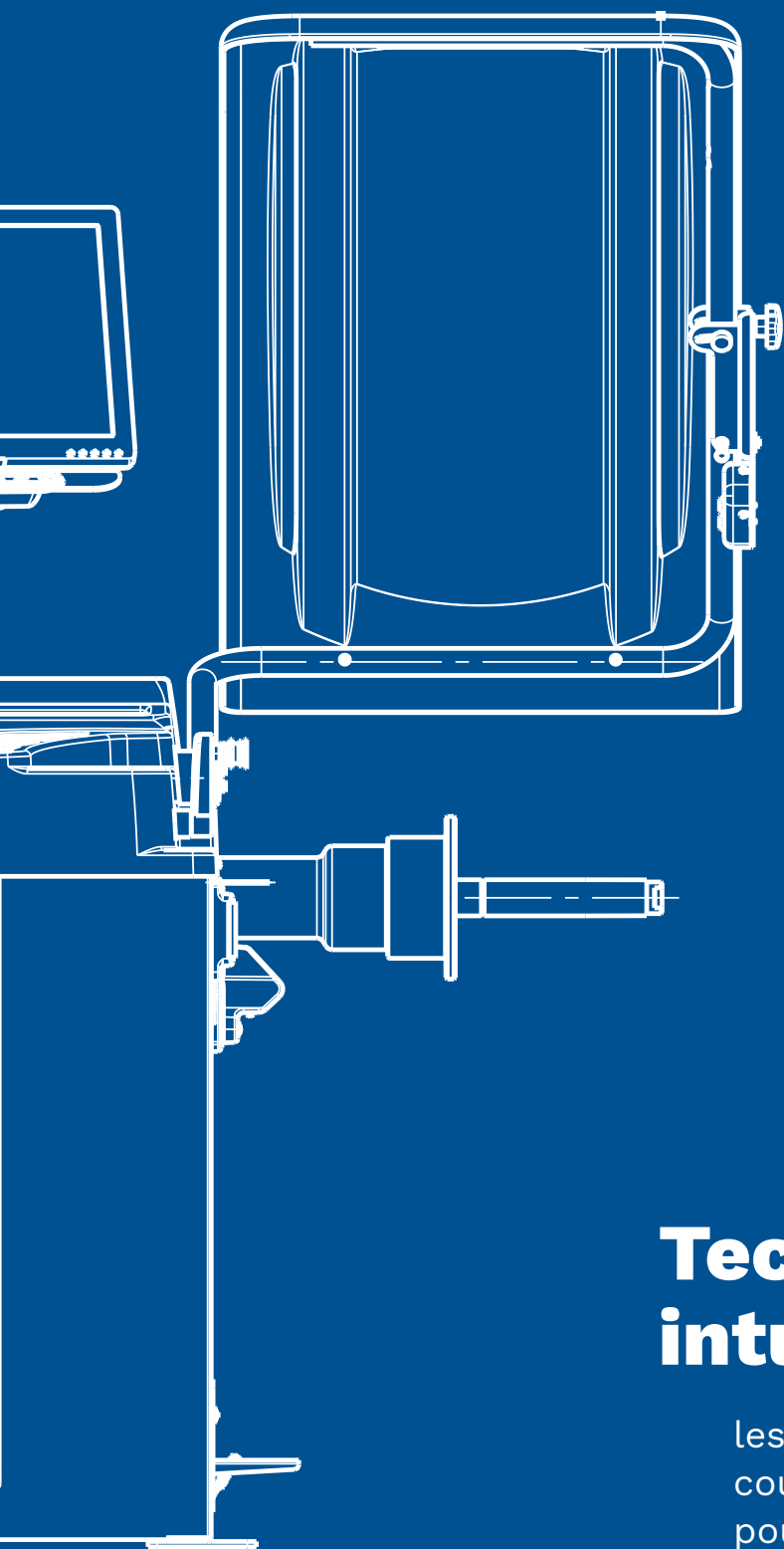

Parfaite précision :

acquisition
automatique des
données de roues
et rayon laser de
positionnement

Design pratique :

chaque chose a
sa place, et au
bon endroit

Technologie intuitive :

les graphiques et
couleurs sont étudiés
pour faciliter l'utilisation
de l'équilibrage de roue



**Equilibreuses électroniques
à microprocesseur **avec
arrêt automatique de la roue****
dans les deux positions de
balourd, extérieur et aussi
intérieur. Selection rapide
par la pige. Enregistrement
automatique de la distance
et du diamètre.

EQUILIBREUSES

Equilibreuses électroniques a microprocesseur

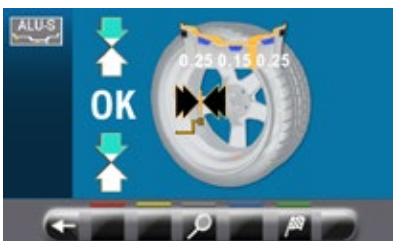
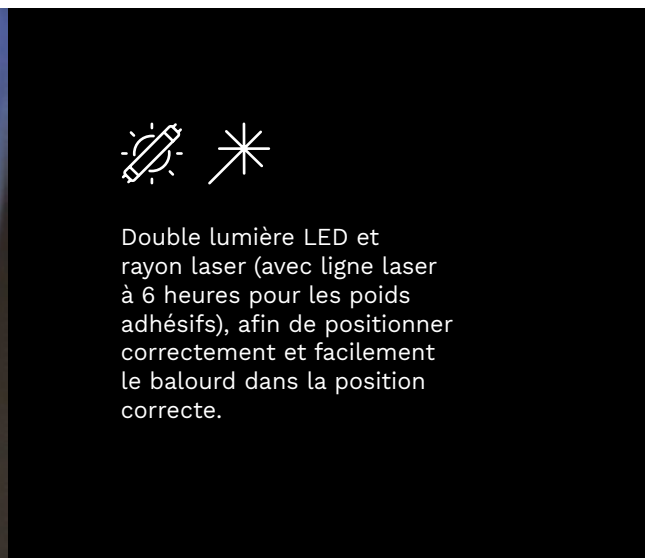
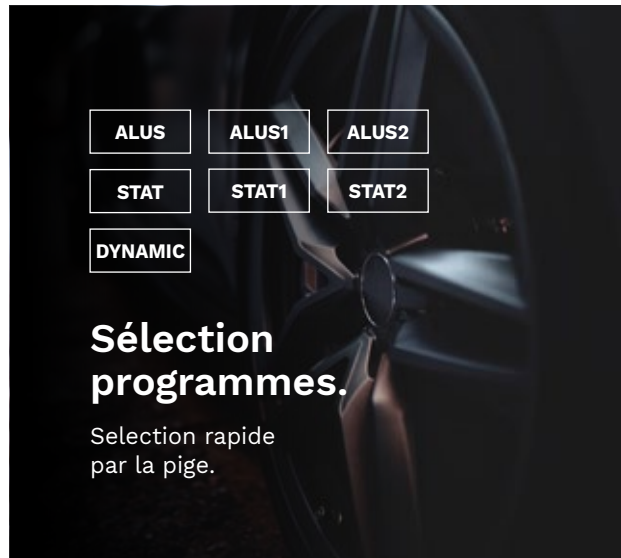



Optimisation de l'espace pour que tout soit pratique et facile.



Qu'il soit standard ou en option, chaque accessoire a sa place désignée.

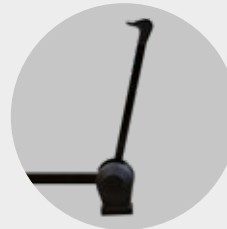

Tige externe.
(Option pour les modèles G3.128NR et G3.150).

Écran tactile
7" avec clavier sensitif.

Moniteur 22"
avec clavier sensitif.



Frette de serrage rapide professionnelle.

Grand logement pour poids à pinces ou adhésifs.

Poche avant pour ranger les outils de travail.

Acquisition automatique de la largeur par abaissement de la protection de la roue (uniquement pour les modèles WS).

Modèle G3.128NR

Modèle G3.150WS



Graphiques comportant des icônes claires pour faciliter l'utilisation de l'équilibreuse de roue.



Compatible avec le système

TEq-Link
connected workshop



CONNEXION INTERNET

Envoi des résultats aux clients.
Assistance à distance.

Données techniques

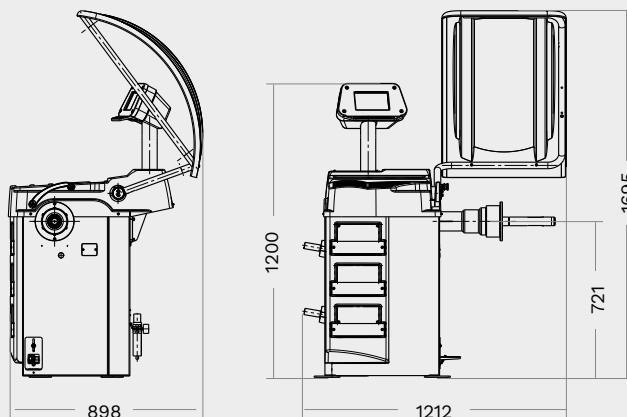





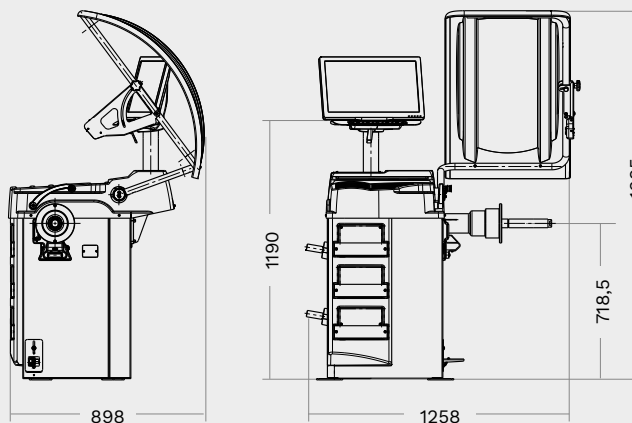



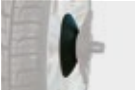
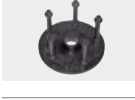

G3.128NR

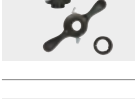
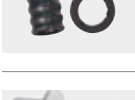
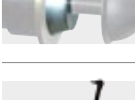
	N° article
GP3.150WSPLUS	RAV.G3150.201287
G3.150WSPLUS	RAV.G3150.201331
GP3.150WS	RAV.G3150.201386
G3.150WS	RAV.G3150.201430
GP3.150S	RAV.G3150.201485
G3.150S	RAV.G3150.201539
G3.150	RAV.G3150.201584
GP3.128NR	RAV.G3128.201300
G3.128NR	RAV.G3128.201355

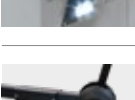

G3.150

	G3.128NR Tous les modèles	G3.150 Tous les modèles
Diamètre de jante min.	10"	10"
Diamètre de jante max.	26"	26"
Largeur de jante min.	1.5"	1.5"
Largeur de jante max.	22"	22"
Poids de la roue max.	70 kg	70 kg
Précision d'équilibrage +/-	1 g	1 g
Temps de mesure	6 s	6 s
Vitesse de mesure	100 tr/min	100 tr/min
Raccordement électrique	230V/50-60/1ph	230V/50-60/1ph

		GP3 150WSPLUS	G3 150WSPLUS	GP3 150WS	G3 150WS	GP3 150S	G3 150S	G3 150	GP3 128NR	G3 128NR
	GAR111 Kit de cônes pour voitures de tourisme (Ø 44 - 112 mm)	S	S	S	S	S	S	S	S	S
	GAR121 Disque de protection	S	S	O	O	O	O	O	O	O
	GAR132 Plateau de précision	S	S	O	O	O	O	O	O	O
	Déecteur pour mesure manuelle de la largeur de roue	S	S	O	O	O	O	O	O	O
	GAR345 Écrou à serrage rapide	S	S	-	S	-	S	S	-	S
	GAR351 Écrou serrage pneumatique	S	S	S	-	S	-	-	S	-
	GAR112 Cône pour SUV	S	S	O	O	O	O	O	O	O
	GAR306 Pige de largeur de roue	O	O	-	-	S	S	O	O	O
	GAR311 Pointeur laser + lumière LED	S	S	S	S	S	S	S	S	S
	GAR315 Sonar d'excentricité	O	O	-	-	O	O	-	O	O
	GAR377 Sonar d'excentricité	O	O	O	O	-	-	-	-	-
	GAR332 Sonar de dimensions de roue	O	O	S	S	-	-	-	-	-
	GAR324 - GAR325 Élévateur de roue	O	O	O	O	O	O	O	O	O
	GAR358 Logiciel de connectivité interne atelier	O	O	O	O	O	O	O	O	O

S Standard **O** Option



RAV Italy

Vehicle Service Group Italy S.r.l.

Via Filippo Brunelleschi 9
44020 Ostellato (FE)
Italy

☎ +39.051.6781511
☎ +39.051.846349
✉ rav@ravaglioli.com

RAV France

RAV France SARL

4, Rue De Longue Raie
ZAC de la Tremblaie
91220 Le Plessis Pâté
France

☎ +331.60.86.88.16
☎ +331.60.86.82.04
✉ rav@ravfrance.fr

RAV Germany

BlitzRotary GmbH

Hüfingener Straße 55
78199 Bräunlingen
Germany

☎ +49.771.9233.0
☎ +49.771.9233.99
✉ ravd@ravaglioli.com

RAV UK

Vehicle Service Group UK Ltd

3 Fourth Avenue,
Bluebridge Industrial Estate
Halstead, Essex, CO9 2SY
United Kingdom

☎ +44.1787.477711
☎ +44.1787.477720
✉ rav@ravaglioli.com

DRJ19U(02)

Les caractéristiques techniques et illustrations présentées dans cette brochure ne sont pas contraignantes. Nos produits sont sujets à des modifications techniques, et l'état à la livraison peut donc différer.

Member of VSG - Vehicle Service Group
a  company

