

ALLEGATO 1 AL MANUALE DI ISTRUZIONI INFORMAZIONI SUL FABBRICANTE

In tutte le parti del presente manuale nelle quali si fa riferimento, quale fabbricante, a una delle seguenti società:

- Ravaglioli S.p.A., P.IVA e C.F.: 01759471202, con sede legale in Sasso Marconi (BO), Via 1° Maggio, 3, Italia
- Butler Engineering and Marketing S.p.A., P.IVA: 01741580359, C.F.: 01824810368, con sede legale in Rolo (RE), Via dell'Ecologia, 6, Italia
- Space S.r.l., P.IVA e C.F.: 07380730015, con sede legale in Trana (TO), Via Sangano, 48, Italia

tale società deve essere intesa come:

Vehicle Service Group Italy S.r.l.

P.IVA: 01426630388

C.F.: 01633631203

con sede legale in Ostellato (FE), Via Brunelleschi, 9, Italia

per effetto della intervenuta fusione per incorporazione delle citate Ravaglioli S.p.A., Butler Engineering and Marketing S.p.A. e Space S.r.l. in Officine Meccaniche Sirio S.r.l., ridenominata, a seguito della fusione, Vehicle Service Group Italy S.r.l., avente efficacia giuridica a far data dal 1° luglio 2023.

Il presente Allegato 1 al Manuale di istruzioni costituisce parte integrante del Manuale di istruzioni stesso.

Simone Ferrari

Direttore Generale



Vehicle Service Group Italy S.r.l.

Via Filippo Brunelleschi 9
44020 Ostellato (FE) Italy

VAT no.: 01426630388 | Tax no.: 01633631203

ANNEX 1 TO THE INSTRUCTION MANUAL MANUFACTURER INFORMATION

In all parts of the present manual in which reference is made to one of the following companies as the manufacturer:

- Ravaglioli S.p.A., VAT Number and Tax Code: 01759471202, with registered office in Sasso Marconi (BO), Via 1° Maggio, 3, Italy
- Butler Engineering and Marketing S.p.A., VAT Number: 01741580359, Tax Code: 01824810368, with registered office in Rolo (RE), Via dell'Ecologia, 6, Italy
- Space S.r.l., VAT Number and Tax Code: 07380730015, with registered office in Trana (TO), Via Sangano, 48, Italy

this company is to be understood as:

Vehicle Service Group Italy S.r.l.

VAT Number: 01426630388

Tax Code: 01633631203

with registered office in Ostellato (FE), Via Brunelleschi, 9, Italy

as a result of the intervened merger by incorporation of the aforementioned Ravaglioli S.p.A., Butler Engineering and Marketing S.p.A. and Space S.r.l. into Officine Meccaniche Sirio S.r.l., renamed, following the merger, as Vehicle Service Group Italy S.r.l., having legal effect as of July 1st, 2023.

This Annex 1 to the Instruction Manual is an integral part of the Instruction Manual itself.

Simone Ferrari

Managing Director



Vehicle Service Group Italy S.r.l.

Via Filippo Brunelleschi 9
44020 Ostellato (FE) Italy

VAT no.: 01426630388 | Tax no.: 01633631203

ANLAGE 1 ZUR BEDIENUNGSANLEITUNG HERSTELLERANGABEN

In allen Teilen der vorliegenden Bedienungsanleitung, in denen auf eine der folgenden Gesellschaften:

- Ravaglioli S.p.A., Umsatzsteuer-Identifikationsnummer und Italienische Steuernummer: 01759471202, mit Rechtssitz in Sasso Marconi (BO), Via 1° Maggio, 3, Italien
- Butler Engineering and Marketing S.p.A., Umsatzsteuer-Identifikationsnummer 01741580359, und Italienische Steuernummer: 01824810368, mit Rechtssitz in Rolo (RE), Via dell'Ecologia, 6, Italien
- Space S.r.l., Umsatzsteuer-Identifikationsnummer und Italienische Steuernummer: 07380730015, mit Rechtssitz in Trana (TO), Via Sangano, 48, Italien

als Hersteller Bezug genommen wird, ist diese Gesellschaft zu verstehen als:

Vehicle Service Group Italy S.r.l.

UMSATZSTEUER-IDENTIFIKATIONSNUMMER: 01426630388

ITALIENISCHE STEUERNUMMER: 01633631203

mit eingetragenem Rechtssitz in Ostellato (FE), Via Brunelleschi, 9, Italien

als Folge der verschmelzenden Übernahme der vorgenannten Ravaglioli S.p.A., Butler Engineering and Marketing S.p.A. und Space S.r.l. in die Officine Meccaniche Sirio S.r.l., die nach der Verschmelzung mit rechtlicher Wirkung zum 1. Juli 2023 in Vehicle Service Group Italy S.r.l. umbenannt wurde.

Die vorliegende Anlage 1 zur Bedienungsanleitung ist integrierender Bestandteil der Betriebsanleitung selbst.

Simone Ferrari

Geschäftsführer



Vehicle Service Group Italy S.r.l.

Via Filippo Brunelleschi 9
44020 Ostellato (FE) Italy
VAT no.: 01426630388 | Tax no.: 01633631203

ANNEXE 1 DU MANUEL D'INSTRUCTIONS INFORMATIONS SUR LE FABRICANT

Dans toutes les parties de ce manuel où il est fait référence à l'une des sociétés suivantes en tant que fabricant:

- Ravaglioli S.p.A., numéro de TVA et code fiscal: 01759471202, dont le siège social est situé à Sasso Marconi (BO), Via 1° Maggio, 3, Italie
- Butler Engineering and Marketing S.p.A., numéro de TVA: 01741580359, code fiscal: 01824810368, dont le siège est à Rolo (RE), Via dell'Ecologia, 6, Italie
- Space S.r.l., numéro de TVA et code fiscal: 07380730015, dont le siège est à Trana (TO), Via Sangano, 48, Italie

cette société doit être sous-entendue comme:

Vehicle Service Group Italy S.r.l.

numéro de TVA: 01426630388

code fiscal: 01633631203

dont le siège social est situé à Ostellato (FE), Via Brunelleschi, 9, Italie

à la suite de la fusion par incorporation des sociétés Ravaglioli S.p.A., Butler Engineering and Marketing S.p.A. et Space S.r.l. dans Officine Meccaniche Sirio S.r.l., renommée, à la suite de la fusion, Vehicle Service Group Italy S.r.l., avec effet juridique à compter du 1er juillet 2023.

La présente Annexe 1 au Manuel d'instructions fait partie intégrante du Manuel d'instructions lui-même.

Simone Ferrari

Directeur Général



Vehicle Service Group Italy S.r.l.

Via Filippo Brunelleschi 9
44020 Ostellato (FE) Italy

VAT no.: 01426630388 | Tax no.: 01633631203

ANEXO 1 AL MANUAL DE INSTRUCCIONES INFORMACIÓN DEL FABRICANTE

En todas las partes de este manual en las que se haga referencia a una de las siguientes empresas como fabricante:

- Ravaglioli S.p.A., número de IVA y código fiscal: 01759471202, con domicilio social en Sasso Marconi (BO), vía 1° Maggio, 3, Italia
- Butler Engineering and Marketing S.p.A., número de IVA: 01741580359, código fiscal: 01824810368, con domicilio social en Rolo (RE), vía dell'Ecologia, 6, Italia
- Space S.r.l., número de IVA y código fiscal: 07380730015, con domicilio social en Trana (TO), vía Sangano, 48, Italia

que debe entenderse por sociedad:

Vehicle Service Group Italy S.r.l.

Número de IVA: 01426630388

código fiscal: 01633631203

con domicilio social en Ostellato (FE), vía Brunelleschi, 9, Italia

como resultado de la fusión por incorporación de las mencionadas Ravaglioli S.p.A., Butler Engineering and Marketing S.p.A. y Space S.r.l. en Officine Meccaniche Sirio S.r.l., rebautizada, tras la fusión, Vehicle Service Group Italy S.r.l., con efectos jurídicos a partir del 1 de julio de 2023.

El presente Anexo 1 del Manual de Instrucciones forma parte integrante del mismo.

Simone Ferrari

Director Gerente



Vehicle Service Group Italy S.r.l.

Via Filippo Brunelleschi 9
44020 Ostellato (FE) Italy

VAT no.: 01426630388 | Tax no.: 01633631203

RAVTD2.0WIFI

MANUALE DI ISTRUZIONE
INSTRUCTION MANUAL
BETRIEBSANLEITUNG
MANUEL D'INSTRUCTIONS
MANUAL DE INSTRUCCIONES

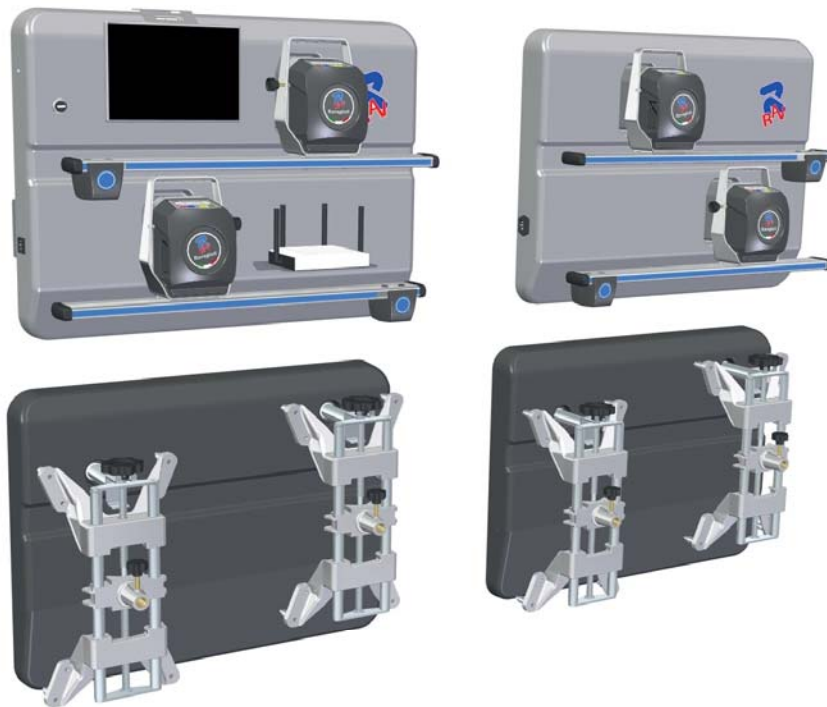

COMPOSIZIONE

49 pagine (copertine comprese)
47 pagine numerate

COMPOSITION

49 pages (including cover pages)
47 numbered pages

ZUSAMMENSETZUNG

49 Seiten
(inkl. Deckblätter)
47 nummerierte Seiten

COMPOSITION

49 pages (pages de la couverture incluses)
47 pages numérotées

COMPOSICIÓN

49 páginas (incluidas las portadas)
47 páginas numeradas

- Per eventuali chiarimenti interpellare il più vicino rivenditore oppure rivolgersi direttamente a:
- For any further information please contact your local dealer or call:
- Im Zweifelsfall oder bei Rückfragen wenden Sie sich bitte an den nächsten Wiederverkäufer oder direkt an:
- Pour tout renseignement complémentaire s'adresser au revendeur le plus proche ou directement à:
- En caso de dudas, para eventuales aclaraciones, póngase en contacto con el distribuidor más próximo ó diríjase directamente a:

SIMBOLOGIA UTILIZZATA NEL MANUALE
SYMBOLS USED IN THE MANUAL
IN DER BETRIEBSANLEITUNG VERWEDETE ZEICHEN
SYMBOLES UTILISES DANS LA NOTICE
SIMBOLOGÍA UTILIZADA EN EL MANUAL



| | SIMBOLI | SYMBOLS | ZEICHEN | SYMBOLES | SÍMBOLOS |
|---|--|--|---|--|---|
|  | VIETATO! | FORBIDDEN! | VERBOTEN | INTERDIT! | PROHIBIDO! |
|  | Obbligo! Operazioni o interventi da eseguire obbligatoriamente | Mandatory! Operations or jobs to be performed compulsorily | Vorschrift Obligatorisch auszuführende Arbeitsvorgänge oder Eingriffe | Obligation. Opérations ou interventions obligatoires | Obigación. Operaciones o intervenciones que hay que realizar obligatoriamente |
|  | Pericolo! Prestare particolare attenzione | Hazard! Be especially careful | Gefahr! Äusserste Vorsicht ist geboten | Dager! Faire très attention | Peligro! Prestar especial atención |



TABLE OF CONTENTS

| | | |
|----------|---|-----------|
| 1 | WARNINGS | 3 |
| 1.1 | Preliminary safety information | 3 |
| 2 | INTENDED USE | 4 |
| 3 | TRAINING OF THE PERSONNEL | 4 |
| 3.1 | Mesure générales de prévention | 4 |
| 4 | COMPOSITION OF THE EQUIPMEN | 5 |
| 4.1 | Clamp compartment (optional) | 6 |
| 4.1.1 | STDA156 (wall-mounted panels) | 6 |
| 4.1.2 | STDA155 (clamp trolley) | 6 |
| 4.1.3 | STDA157 (wall hooks) | 6 |
| 4.2 | Measuring ranges and accuracy | 7 |
| 4.3 | Overall dimensions | 7 |
| 4.4 | Tablet | 8 |
| 4.5 | Access Point | 8 |
| 4.6 | Detectors | 9 |
| 4.6.1 | Detector keypads | 10 |
| 4.6.2 | Detector automatic switching off | 10 |
| 4.6.3 | Low battery warning | 10 |
| 4.7 | Clamps | 11 |
| 4.7.1 | STDA33EU clamps | 11 |
| 4.7.2 | STDA35E clamps | 11 |
| 4.8 | Turntables | 12 |
| 4.8.1 | S110A7/P turntables | 12 |
| 5 | APPLICATION SETTING | 13 |
| 5.1 | Program Configuration | 13 |
| 5.2 | Connecting detectorss | 16 |
| 5.2.1 | Internet connection | 17 |
| 5.3 | DATABASE configuration | 18 |
| 5.3.1 | Changing Groups | 18 |
| 5.3.2 | Adding new Groups | 19 |
| 5.3.3 | Info and Database Update | 19 |
| 6 | DIAGNOSIS AND ADJUSTMENT OF A VEHICLE | 20 |
| 6.1 | Selecting the brand and model of a vehicle | 20 |
| 6.2 | Search vehicles by license plate number with "SHOOT & GO" | 22 |
| 6.3 | Displaying technical data of the selected vehicle | 24 |
| 6.3.1 | Displaying ADDITIONAL MEASUREMENTS on CHASSIS HEIGHTS | 25 |



| | | |
|--------|---|----|
| 6.3.2 | Displaying CHECK MEASUREMENTS on CHASSIS HEIGHTS | 26 |
| 6.3.3 | Displaying ADJUSTMENT HELP images | 27 |
| 6.4 | Preliminary operations | 28 |
| 6.4.1 | Preliminary vehicle inspection operations | 28 |
| 6.4.2 | Run-Out preparation | 28 |
| 6.5 | Run-Out | 28 |
| 6.5.1 | Push Run-Out procedure with automatic acquisition | 28 |
| 6.6 | Measurement preliminary operations | 30 |
| 6.7 | Aligning and levelling detectors | 30 |
| 6.8 | Steering procedure | 31 |
| 6.9 | Vehicle Diagnosis | 32 |
| 6.10 | Adjustment preliminary operations | 32 |
| 6.11 | Adjusting the rear axle | 33 |
| 6.12 | Adjusting the front axle | 34 |
| 6.12.1 | “Jack-Hold” procedure | 35 |
| 6.13 | Summary of DIAGNOSIS and ADJUSTMENT data | 36 |
| 6.13.1 | Chassis diagnosis | 36 |
| 6.14 | Printing the measurements made | 37 |
| 6.14.1 | Example of table printing | 38 |
| 6.14.2 | Example of graphic printing | 39 |
| 6.15 | Sharing the test carried out | 40 |
| 6.16 | Saving the tests performed with TEq-Link | 41 |
| 6.16.1 | Configuring the TEq-Link function | 41 |
| 7 | FRONT AXLE SPOILER PROCEDURE | 42 |
| 8 | ERROR SIGNALLING | 44 |
| 8.1 | Data transmission error between detectors | 44 |
| 8.2 | Angle measurement error in the horizontal plane | 45 |
| 9 | PROBLEMS | 45 |
| 10 | MAINTENANCE | 46 |
| 11 | DECOMMISSIONING AND SCRAPPING | 46 |
| 12 | MACHINE IDENTIFICATION DATA | 47 |

1 WARNINGS

Any damage resulting from the failure to observe the instructions in this manual and improper use of the machine releases the manufacturer from any liability.

1.1 Preliminary safety information



Before turning on the equipment:

- Read the instructions and the entire manual before using or working on the wheel aligner. This manual is an integral part of the product and is intended to provide the user with instructions on the use of wheel aligner RAVTD2.0WiFi. Keep it for the entire operating life of the machine, in a known and easily accessible place and consult it whenever doubts arise. All operators working on the product must be able to read the manual.
- Check that the power supply complies with the specifications on the data plate. The voltage and frequency data plate is located at the back of the equipment. Please note the information on the data plate. NEVER connect the equipment to a voltage or frequency other than those indicated.
- Properly fix the wheel aligner power cord. This product is equipped with a 3-wire plug with built-in grounding. It can be plugged only into a socket that is also grounded. If it is not possible to insert the plug into a socket of this type, please consult an electrician. Do not modify or misuse the plug.

In emergency conditions and before any maintenance work:

- Insulate the machine from energy sources, using the machine's main switch and remove the plug from the power socket.
- Do not attempt to service this unit arbitrarily, as removing the panels could expose you to dangerous voltages; maintenance should only be performed by authorised service personnel.

Working environment and equipment cleanliness:

- The working environment must be kept clean, dry, not exposed to the weather and sufficiently illuminated.
- Avoid cleaning the equipment with jets of water and compressed air.
 1. When cleaning plastic panels or shelves use a damp cloth (avoid liquids containing solvents in any case).

Ravaglioli S.p.A may make changes to the models described in this manual at any time for technical or commercial reasons.



TEq-Link and **SHOOT&GO** brands are owned by Ravaglioli S.p.A.

All the other mentioned trademarks, displayed logos and images belong to their rightful owners, which hold all the relevant rights.

2 INTENDED USE

RAVTD2.0WiFi systems are equipment for full detection of characteristic angles of motor vehicles. The angle detection is carried out by four detectors with microprocessor technology and infrared measuring and data transmission system (without using cable connections between the detectors).

The data transmission from the front cab detectors is performed VIA RADIO by means of modules



The maximum permissible length of the vehicle wheelbase, to allow data transmission and angle measurement, is 4.5m.

Temperature range for the use of the equipment between 0 and 40°C.

3 TRAINING OF THE PERSONNEL

Only specially trained and authorised personnel are allowed to use the equipment. In order for the machine to be operated optimally and for measurements to be carried out efficiently, it is necessary for the personnel in charge to be properly trained to learn the necessary information in order to achieve an operating mode in line with the manufacturer's instructions. For any doubt regarding the use and maintenance of the machine, consult the instruction manual; in case of doubts do not interpret it, but consult the authorised service centres or directly the technical assistance.

3.1 Mesure générales de prévention



- When operating and maintaining this machine, it is imperative to comply with all applicable safety and accident prevention regulations.



- The equipment must only be used by authorised and properly trained personnel.



- This equipment should be used only for its intended use. The supplier declines all liability for damage to people, animals and things caused by improper use of the machine.



- The installation of accessories and spare parts must be carried out by personnel authorised by the manufacturer using only original accessories and spare parts



- The machine must operate only in places where there is no risk of explosion or fire.



- Removal or modification of safety devices or warning signs on the machine may cause serious danger and constitutes a violation of the European safety standards.



- Before performing any maintenance work on the system, the power supply must be switched off. In case of doubt do not interpret, please contact the technical assistance in advance in order to receive instructions on how to carry out operations in conditions of maximum safety.



- Do not allow unauthorised personnel to approach the wheel aligner during use.

4 COMPOSITION OF THE EQUIPMEN

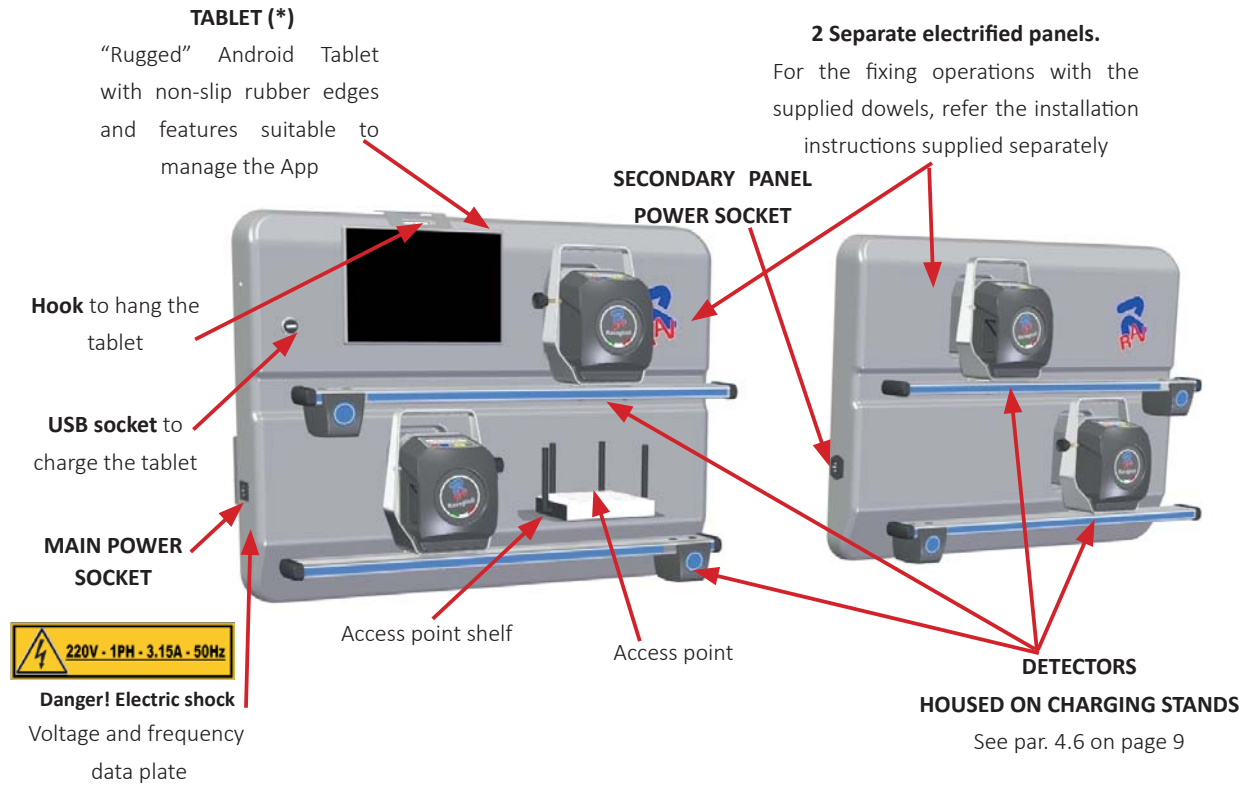

- Figure 1 -

PEDAL LOCK is a tool used to lock the brake pedal when preparing for measurements. It is to be used as shown in the instructions that are displayed during the program. .



STEERING LOCK is a tool used to lock the steering wheel in a fixed position. It is used prior to the adjustment procedure as shown in the instructions that are displayed during the program.



CLAMPS

See par. 4.7 on page 11

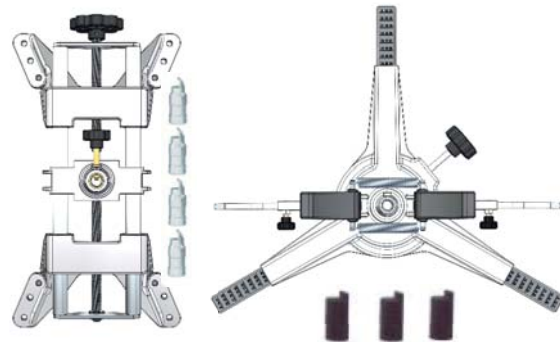

TURNTABLES

See par. 4.8 on page 12



(*) Note: The Tablet may or may not be included in the scope of supply, depending on the outfit of the wheel aligner purchased

4.1 Clamp compartment (optional)

4.1.1 STDA156 (wall-mounted panels)

2 embossed thermoformed wall-mounted panels are available as an option in a size similar to that of detector panels. For the fixing with the supplied dowels, refer to the installation instructions supplied separately.

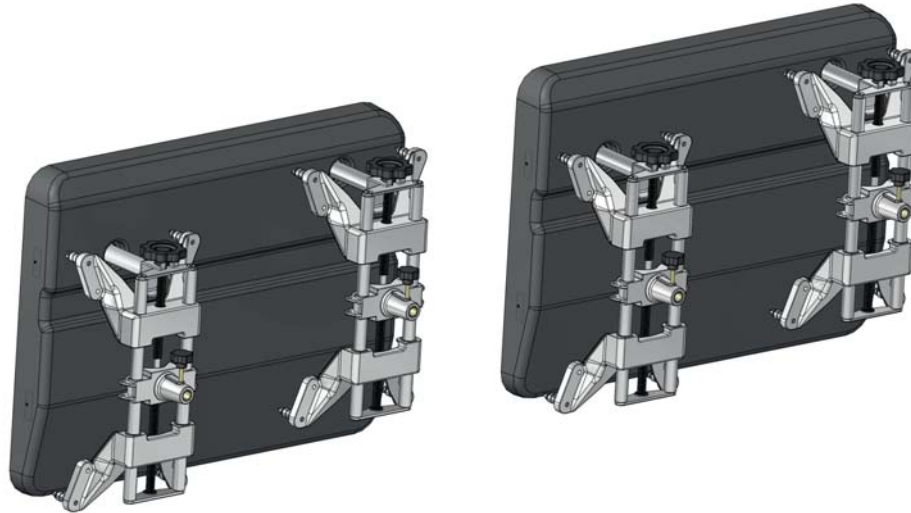

- Figure 2 -

4.1.2 STDA155 (clamp trolley)

A trolley for clamps, pedal lock and steering lock is available as an option.

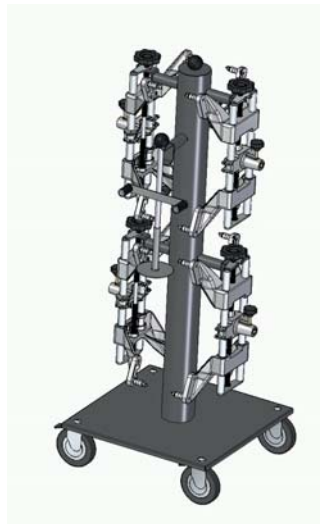

- Figure 3 -

4.1.3 STDA157 (wall hooks)

No.4 hooks are available as an option to fix clamps to the wall with dowels.



4.2 Measuring ranges and accuracy

| Axle | Measurement | Accuracy | Measuring range | Total measuring range |
|-------|--------------|----------|-----------------|-------------------------|
| | | | | |
| Front | Total toe | $\pm 2'$ | $\pm 2^\circ$ | $\pm 20^\circ \times 2$ |
| | Partial toe | $\pm 1'$ | $\pm 1^\circ$ | $\pm 20^\circ$ |
| | Set-back | $\pm 2'$ | $\pm 2^\circ$ | $\pm 5^\circ$ |
| | Camber | $\pm 2'$ | $\pm 3^\circ$ | $\pm 10^\circ$ |
| | Caster | $\pm 5'$ | $\pm 10^\circ$ | $\pm 18^\circ$ |
| | King-pin | $\pm 5'$ | $\pm 10^\circ$ | $\pm 18^\circ$ |
| Rear | Total toe | $\pm 2'$ | $\pm 2^\circ$ | $\pm 20^\circ \times 2$ |
| | Partial toe | $\pm 1'$ | $\pm 1^\circ$ | $\pm 20^\circ$ |
| | Set-back | $\pm 2'$ | $\pm 2^\circ$ | $\pm 5^\circ$ |
| | Camber | $\pm 2'$ | $\pm 3^\circ$ | $\pm 10^\circ$ |
| | Thrust angle | $\pm 2'$ | $\pm 2^\circ$ | $\pm 5^\circ$ |

4.3 Overall dimensions

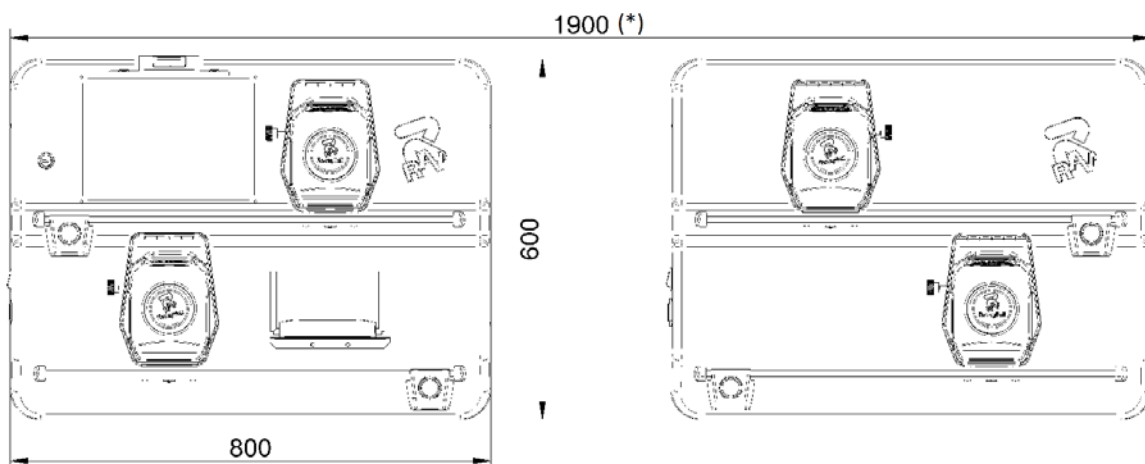

- Figure 4 -

(*) This measure is purely indicative, as the two panels are totally independent and can also be fixed on two different walls.

4.4 Tablet

Depending on the equipment purchased, a “Rugged” **android** tablet with non-slip rubber edges may be included. The Device is supplied with features (see minimum characteristics below) suitable to manage the Aligner APP CCD2.0WiFi.

The table shows the minimum requirements for the operation of the APP:

| | |
|-------------------------------|-----------------|
| Operating system | Android ver. 6 |
| Video Resolution | 1280 x 800 |
| Processor | 1 GHz dual core |
| Internal storage / RAM | 12GB/ 2GB |

If you are using a **iOS** device it is necessary to use tablets with operating system starting from ver. 12. A magnet KIT is included in the equipment supply, which can be glued at the back of the tablet, so that it can be attached directly to the lift. You can also hang it on the vehicle, using the hook provided, highlighted below in blue, which is used to hook it onto the panel (See - Figure 1).



- Figure 5 -

4.5 Access Point

The composition of the equipment includes an Access Point that generates a WiFi network called “connect”, to which the front detectors and the Tablet are connected, thus allowing the transmission of data between Tablet and detectors.



(*) Note: by connecting the WAN port to a data structure access socket with Internet access, you can use the functions needed, see also references on the quick guide code M0335.

You can also temporarily (at the appropriate stages) select a WiFi network with Internet access. The switching between “Internet” and detector “connect” networks can also take place automatically (See 5.2.1 on page 17).



To set configurations different from the one set at the factory, for example to use a pre-existent Wi-Fi network also for detectors, contact the support service authorised by the manufacturer.

4.6 Detectors

The detectors do not need the connection of any cable or lanyard for angle measurement.

The detection units consist of infrared data transmitters/receivers and CCD-type transducers with infrared emitter focal point.

All the characteristic angles of both vehicle axles are controlled by 8 CCD sensors with infrared measurement. Measurement with the infrared system is always effective even in critical lighting conditions.

The front detectors communicate via  modules with the control device (Tablet), connecting to the WiFi network generated by the Access Point (See Chap. 4.5 on page 8)

The data from the rear detectors are transmitted/received by passing through the front detectors, using the infrared transmission.

The power supply is provided by 6V long-life rechargeable batteries. The batteries of the front and rear detectors are recharged by means of the special charging stands located on the panel (See - Chap. 4 , - Figure 1).

Rechargeable battery power data and consumption are as follows:

| | REAR DETECTORS | FRONT DETECTORS |
|---|---------------------------|---------------------------|
| Power supply | NiMH battery 6V - 2000mAh | NiMH battery 6V - 2000mAh |
| Average operation with fully charged battery in full efficiency | About 12 hours | About 10 hours |
| Average recharge time | About 10 hours | About 10 hours |

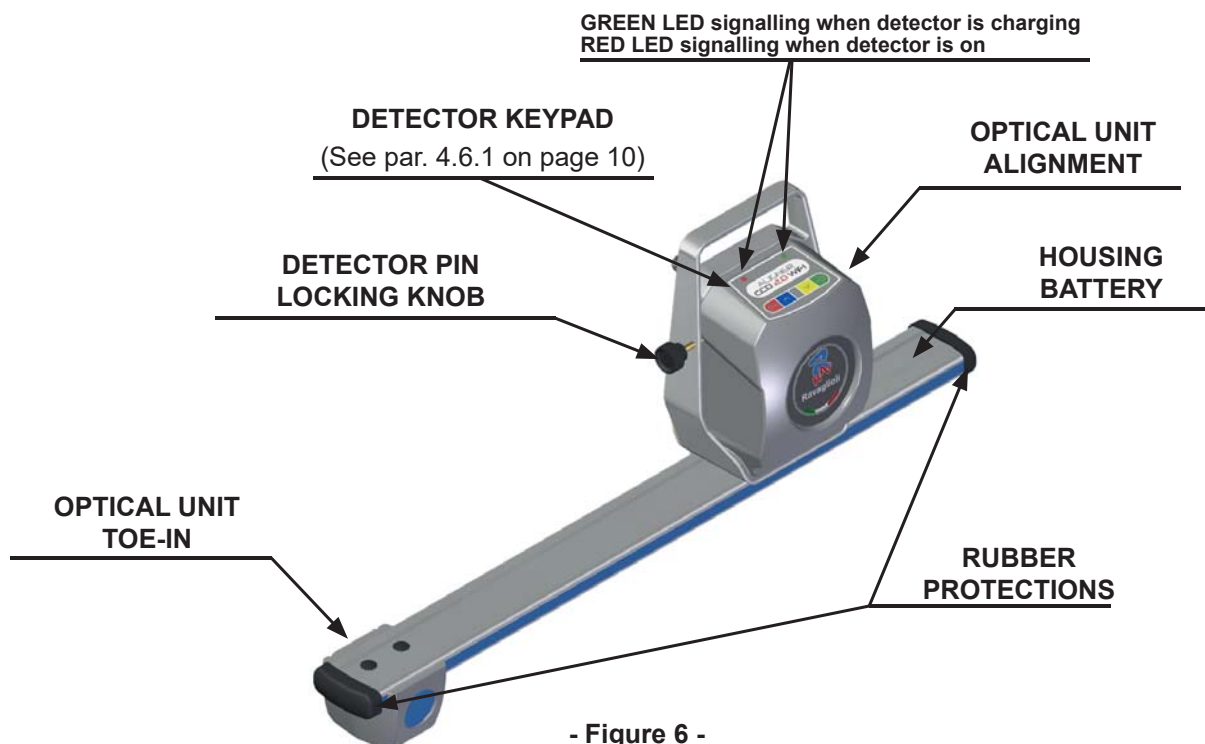

4.6.1 Detector keypads



- Figure 7 -

| KEYS | | DESCRIPTION |
|------|--|--|
| | | Detector power key. |
| | | Pressed at the same time, they manually switch off the detector. |

Key of the - Figure 7:

- | | | |
|----|----------------------|---|
| A- | • Green LED on: | the detector battery is charging |
| B- | • Red LED steady on: | the detector is on |
| | • Red LED flashing: | the detector battery is low (when the remaining battery charge is less than or equal to 30%); it will switch off after a few minutes. |

4.6.2 Detector automatic switching off

The detectors switch off automatically after approx. 5 min. if they are not receiving data, i.e. when the program is in a phase where no data is transmitted/received for the measurement (e.g. on the home page) or if the tablet is switched off. It is always possible to switch off the detectors manually (See tableau au par. 4.6.1) when they are not being used.

4.6.3 Low battery warning

When the residual charge of one or more detectors is LESS than or EQUAL to 30%, the program displays a "Warning" symbol to indicate an error condition (See chap. 8 on page 44).

Click on the "Warning" symbol to display the "low battery" error page showing the charge percentage (- Figure 8). This warning appears also the detector through the flashing of the red power-on LED (See par. 4.6.1 on page 10).

You must put the detector back in charge as soon as possible.

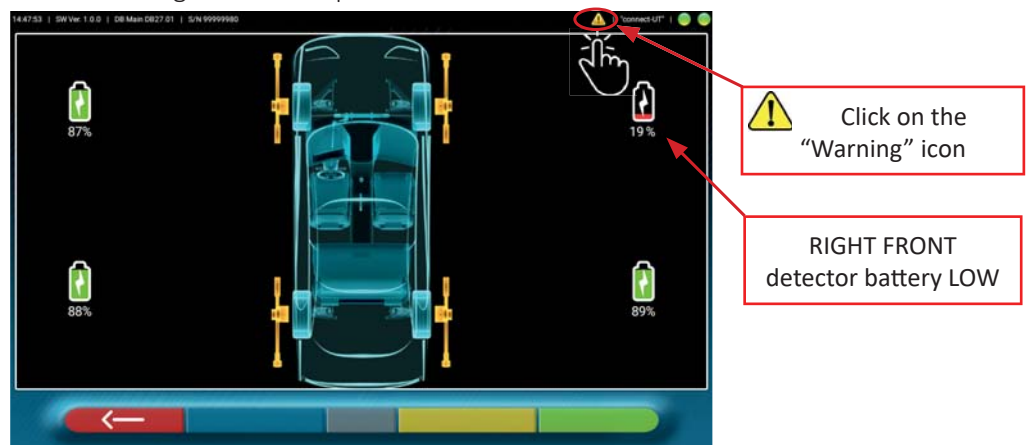

- Figure 8 -

To quit the warning page press key.

4.7 Clamps

Different types of clamps can be included in the scope of supply depending on machine layout.

4.7.1 STDA33EU clamps

Les griffes STDA33EU sont de type à centrage automatique à vis pour roues en alliage de 10 à 24", avec doigts démontables.

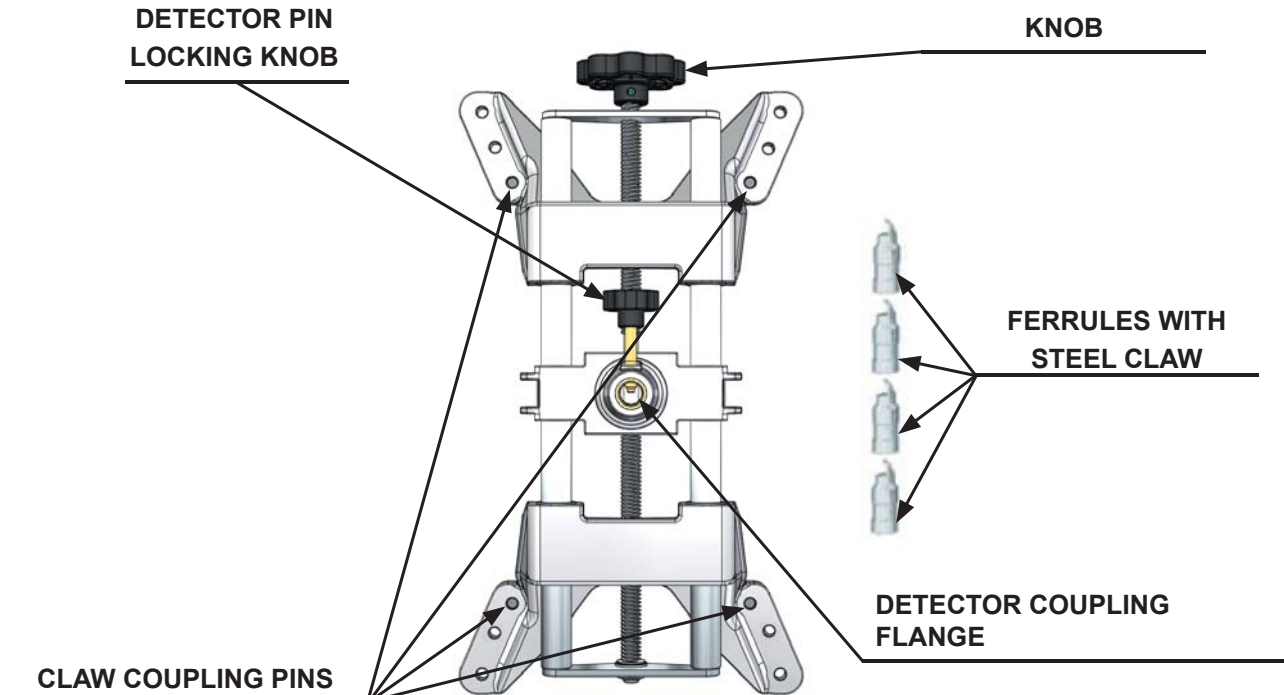

- Figure 9 -

4.7.2 STDA35E clamps

STDA35 clamps are of the 3-point self-centring type for alloy wheels from 10" to 24" with manual approach and locking unit on the tyre.

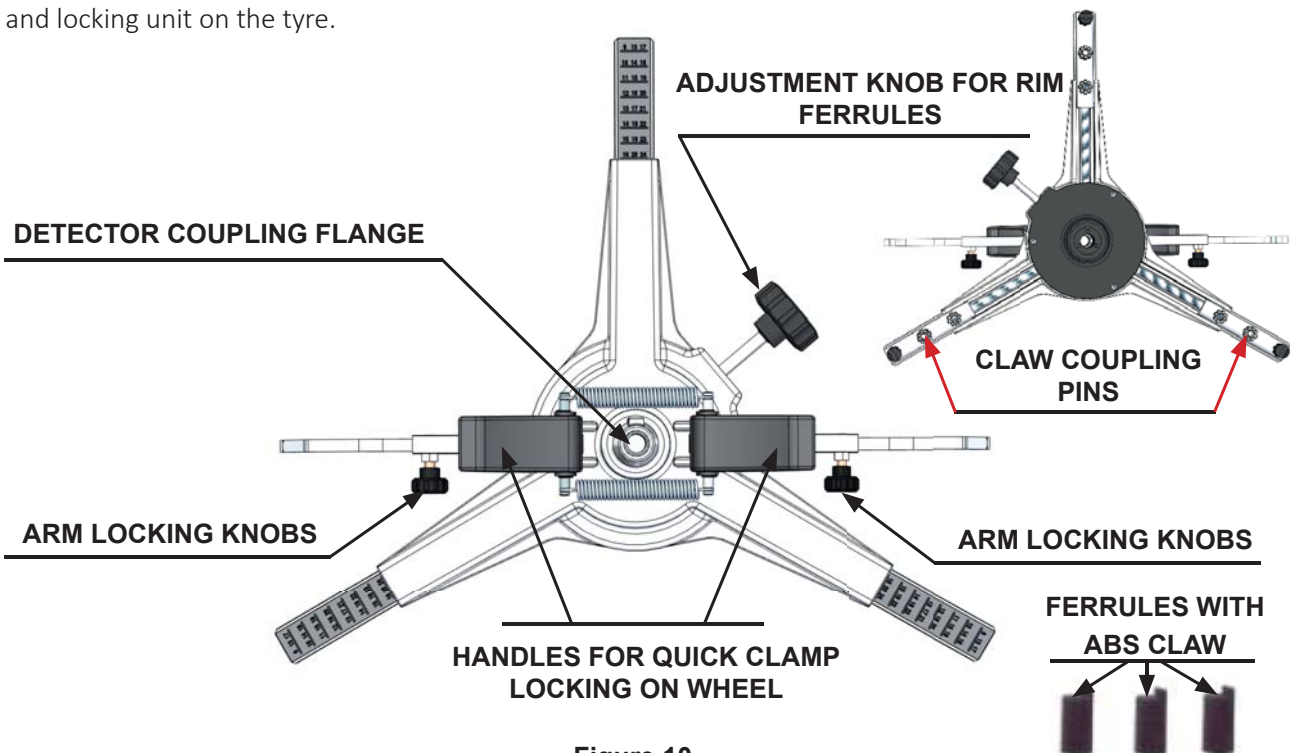

- Figure 10 -

4.8 Turntables

4.8.1 S110A7/P turntables

S110A7/P turntables have a plate diameter of 250 mm and a load capacity of 1,000 kg.

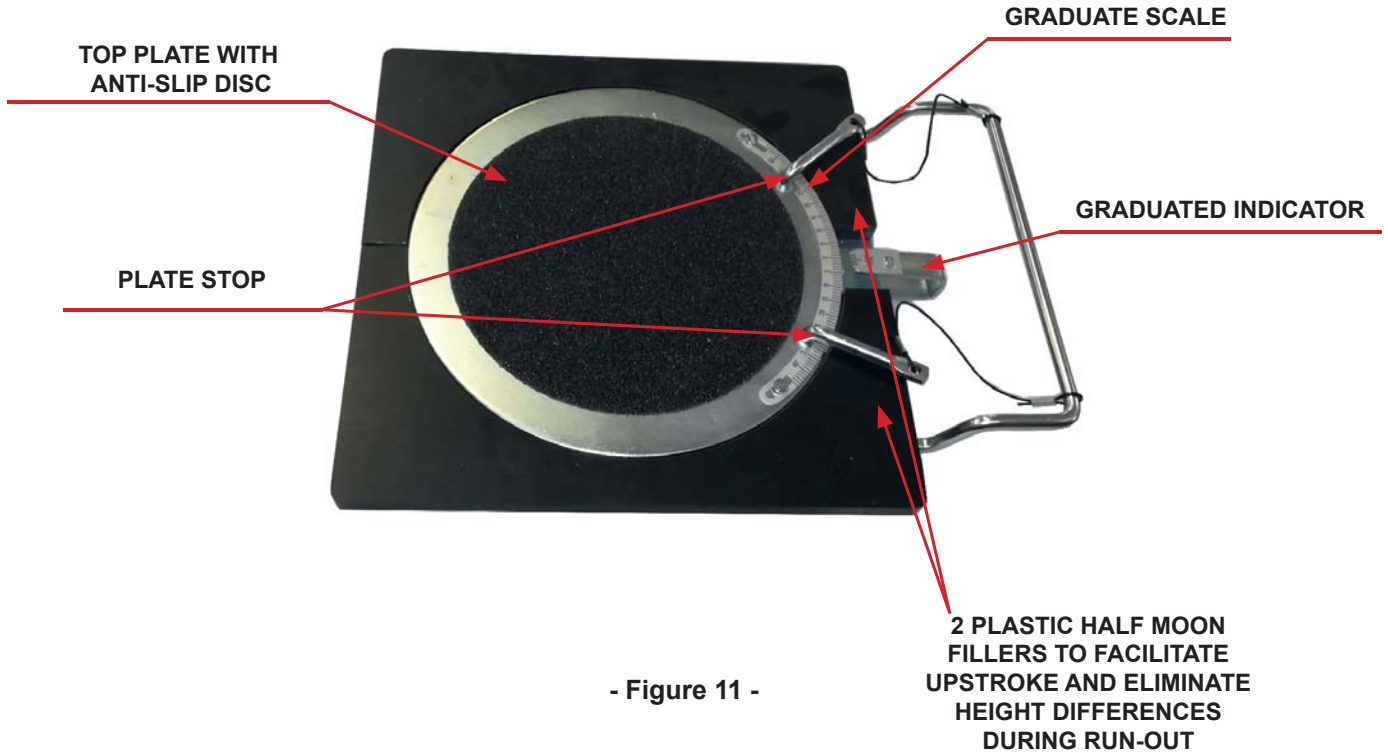

- Figure 11 -

5 APPLICATION SETTING

5.1 Program Configuration



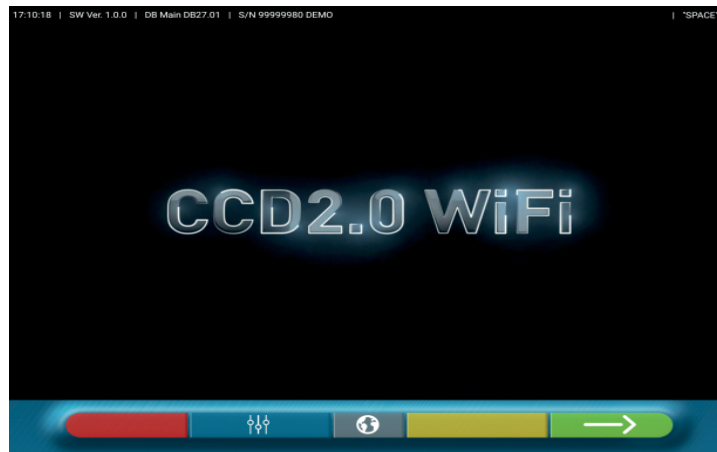

To start the CCD2.0WiFi program click on the icon ; the program starts and the overview page is displayed on the Tablet, from which you can access all the main functions of the equipment. .

Warning!: the functions actually available may depend on the type of device and the version of the operating system you are using.



- Figure 12 -

Select key  to continue and start vehicle diagnosis and adjustment procedure (See par. 6 on page 20).

Select key  to execute the program configuration, you will access a configuration menu that allows you to vary the characteristics of the application according to your needs See - Figure 13.

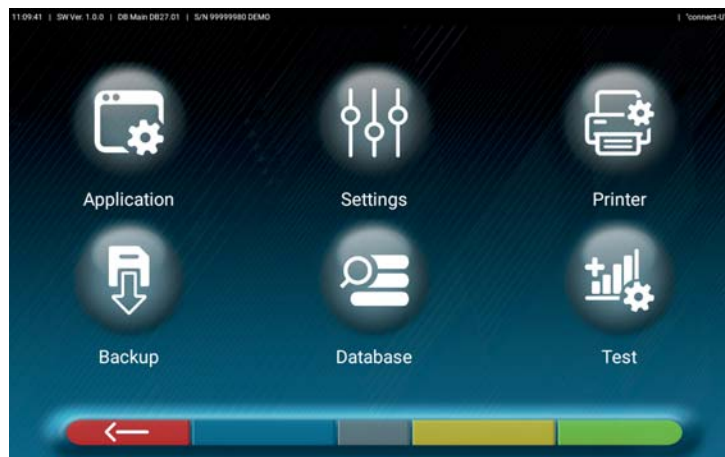

- Figure 13 -

Below are the different possible options related to each of the menus indicated in: - Figure 13



Application: - Figure 14 You can activate and set up features that may be available in your configuration as TEq-Link (par. 6.16 on page 41) and Shoot&Go (par. 6.2 on page 22) .It is possible to perform WiFi search for the connection of front detectors to the network shared with the Tablet (par. 5.2 on page 16). Set the automatic switchover between “Internet” and “connect” networks (See 5.2.1 on page 17). You can configure the sounds associated with events during adjustment or run-out. You can also set the “Demo” mode and access the license activation (see info on quick guide code M0335) and the info on the CCD2.0WiFi App.



- Figure 14 -



Settings: - Figure 15- The parameters regarding units of measurement and angle resolution can be edited: set the “STANDARD” or “USA” toe-in calculation method or display separate tolerances between left and right side.

You can also customise particular wheel alignment procedures such as displaying right- or left-hand drive graphics, and insert search filters on vehicle displaying from log sources.

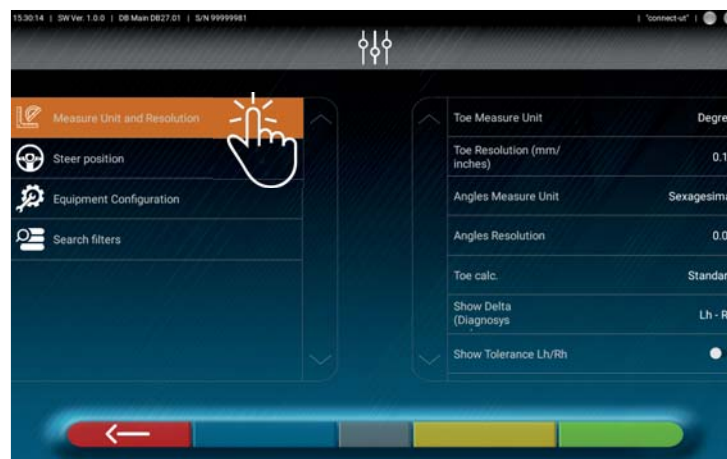

- Figure 15 -



Printer: - Figure 16- In the “Printer” menu you can customise the print report by entering the data at the workshop; you can select the desired type of print (in graphic or table format) and choose the fields you want to enter that will then be displayed in the report (operator, km travelled, chassis number, etc. ...).



- Figure 16 -



Data base: - Figure 17- In the “Database” menu you can configure groups with different brands at will, update the database and read the disclaimers of the data suppliers. See par. 4.3

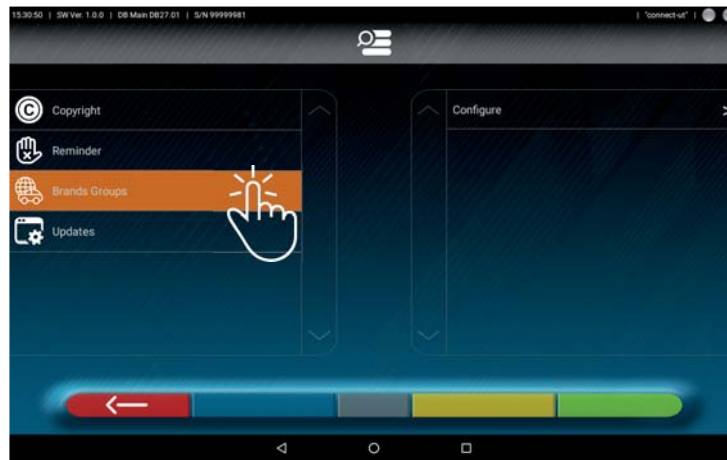

- Figure 17 -



Test:- Figure 18- In the “Test” menu various options are available for the analysis of the functionality of the different detector measuring devices. Instructions for these operations are provided separately and reserved to skilled personnel authorised by the manufacturer.

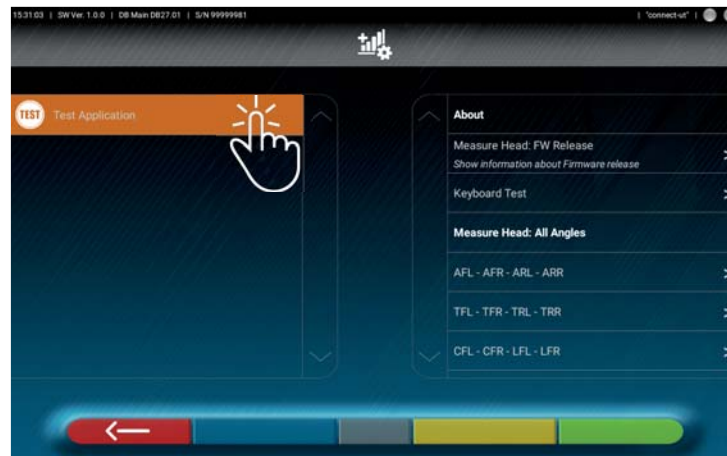

- Figure 18 -



Backup: - Figure 19 - In the “Test” menu there are options to save and restore the set configurations, or restore the factory default App settings.

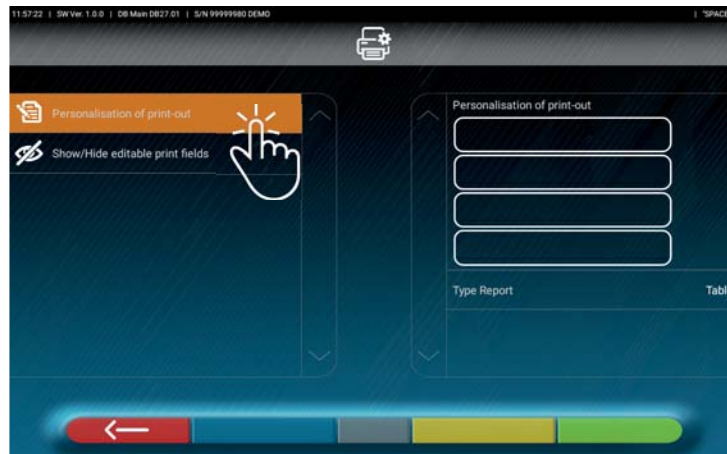

- Figure 19 -

To go back to the configuration menu (- Figure 13-), press key

5.2 Connecting detectors

Before starting to use the wheel aligner SW, if you have not done it before, you must connect the front sensors with the Tablet, through the “WiFi Search” procedure of the configuration menu (See- Figure 13-) Application > Wifi Search > Wifi Scan.



! you must first connect the Tablet to the WiFi network “connect” - See par. 4.5

- Figure 20 -

The page (- Figure 21-) is displayed, where you need to press key to start detector search. When the detectors are found, select the two items (they will be highlighted in orange) and press key to confirm.

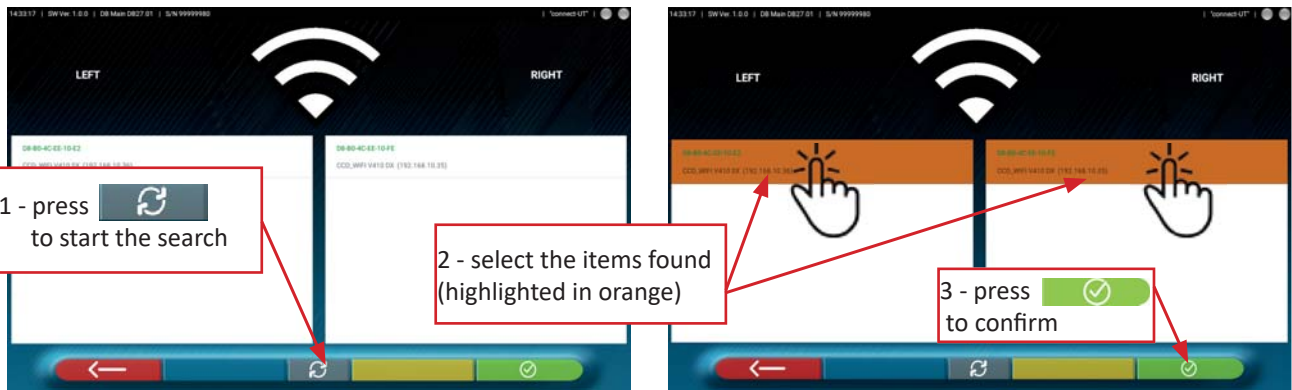

1 - press to start the search

2 - select the items found (highlighted in orange)

3 - press to confirm

- Figure 21 -

The connection status of the 2 front sensors is shown on the top right side:

Front left and right sensors are connected to the Wi-Fi and ready to communicate with the tablet →

Front left and right sensors are not connected to the Wi-Fi (e.g.: they are off) →



Detectors connected

- Figure 22 -

5.2.1 Internet connection

In order to be able to use the features that require an Internet connection (Shoot&Go, TEq-Link, print report sharing) the WAN port of the Access Point must be connected to a data structure access socket with Internet access (See par. 4.5 on page 8).

However, it is also possible to obtain an Internet connection by temporarily using an alternative WiFi network (*). The switching between Internet and “connect” detector networks can be set automatically:

From the configuration menu (See- Figure 13 on page 13) access → Application > Device > and enable the alternative WIFI network with the Onselector switch



- Figure 23 -

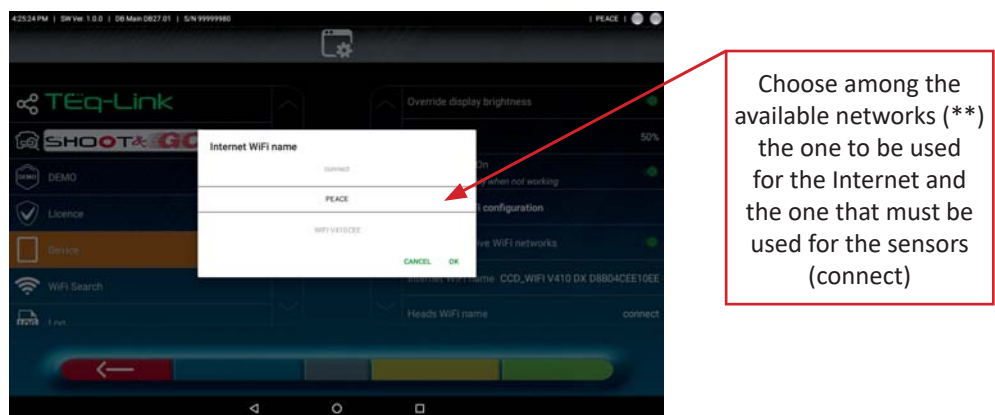

- Figure 24 -

The CCD2.0WiFi application properly manages the switching from the “Internet” network to the “Detectors” network:

- Upon start-up it always connects to the “Internet” network.
- During the Run-Out preparation stage, where you need to connect to the detectors (See- Figure 48 on page 28), it connects to the “Detectors” network (connect).
- At the end, when entering vehicle and customer data (See- Figure 66 on page 37), it connects again to the “Internet” network.

Note (*) The Internet connection via the WAN port of the Access Point guarantees maximum performance. For this reason, it is not recommended to use an alternative WiFi network where the positioning of the antennas and network traffic (overcrowding due to other connected devices) cannot be easily controlled.

Note ():** For **android** devices it is sufficient that the networks in question are stored in the device. For **iOS** devices it is necessary to set, in addition to the “Internet” and “Detectors” networks, the relevant passkeys (they must be WPA2-PSK).

5.3 DATABASE configuration

You can customise the vehicle database, choosing which “groups” to show, or you can create new groups or modify the existing ones by adding or removing brands.

You can view information about the existing databases or check for new updates

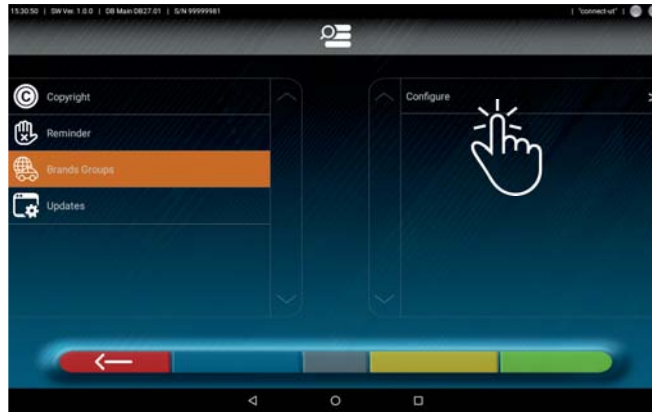

Select the “DATABASE” option  in the program configuration page - See par. 5.1,- Figure 13- then select Brand Groups > Configure



- Figure 25 -



5.3.1 Changing Groups

The page of - Figure 26 displays a list, with the different “profiles” (groups) of the DATABASE, containing the BRANDS of vehicles in circulation in different countries or regions of the world.

Through the  On/  Off switch selectors , you can hide and/or display any group in order to manage the Database according to your needs.



- Figure 26 -

Selecting a group you can also customise it by hiding and/or displaying the brands present, always through the  On/  Off switch selectors .



- Figure 27 -

5.3.2 Adding new Groups

You can also create a new custom group and enter the required brands in it. Click on key , a new entry is generated at the top of the group list. Edit the field highlighted in orange with the name of the desired group.

Then use the On/ Off switch selectors to set the brands to be displayed within the new Group.

Note: to remove a custom group click on key

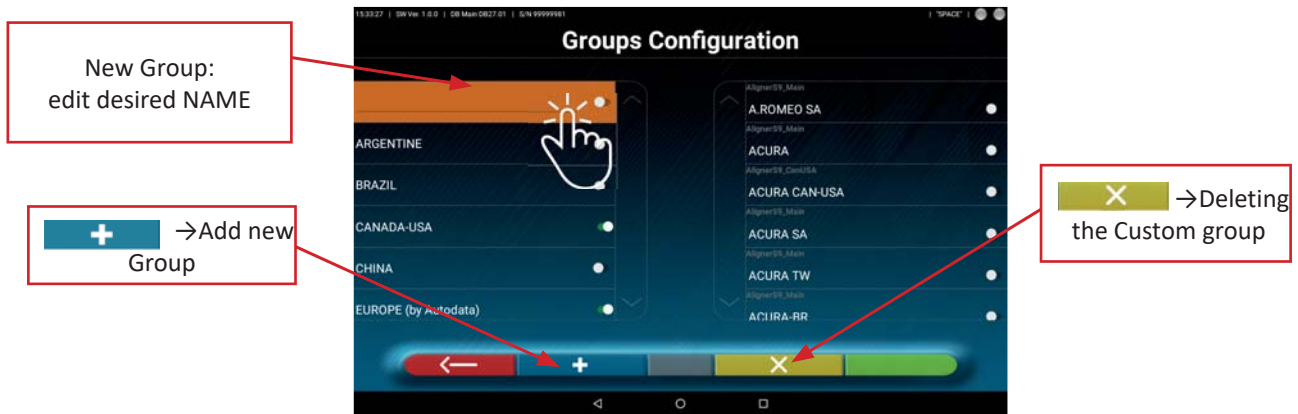

- Figure 28 -

5.3.3 Info and Database Update

By clicking on the “updates” icon you can view information on the configuration and version of the databases present, you can also check the availability of new updates and, if necessary, download them (you must have an Internet connection for this- see quick guide code M0335).



- Figure 29 -

6 DIAGNOSIS AND ADJUSTMENT OF A VEHICLE



To start the CCD2.0WiFi program click on the icon ; the program starts and the home page (- Figure 30) from which you can access the main functions of the equipment, will be displayed.

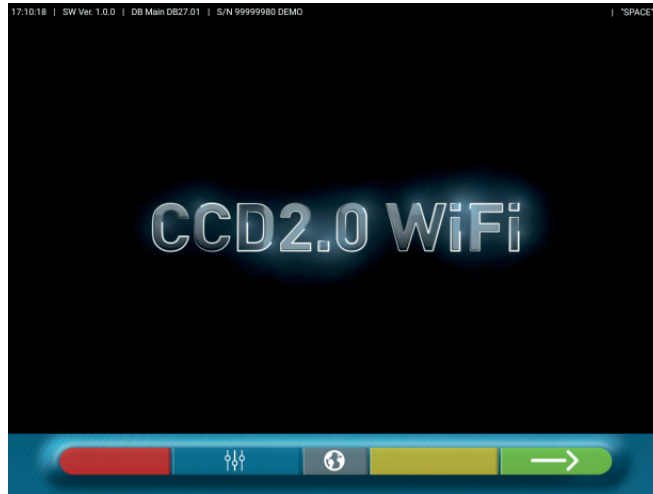

- Figure 30 -

Use key to continue with the selection of the vehicle in the database (See par. 5.1)

6.1 Selecting the brand and model of a vehicle

List with the different groups in the database (See par. 5.3 on page 18)

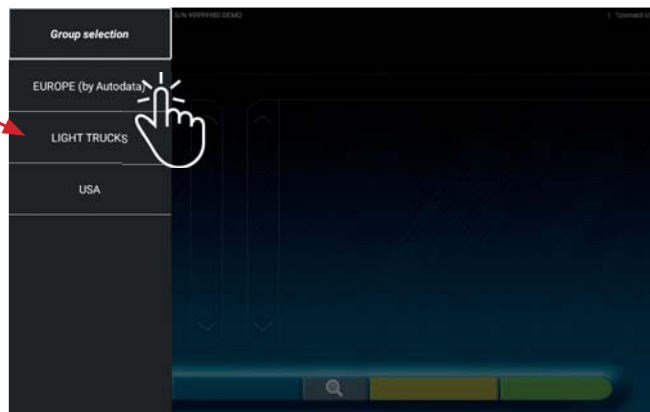

- Figure 31 -

Select the group from those available, the program shows the list of brands of the selected group (See- Figure 32). Scrolling up and down the lists, select the brand of the vehicle and then the model.

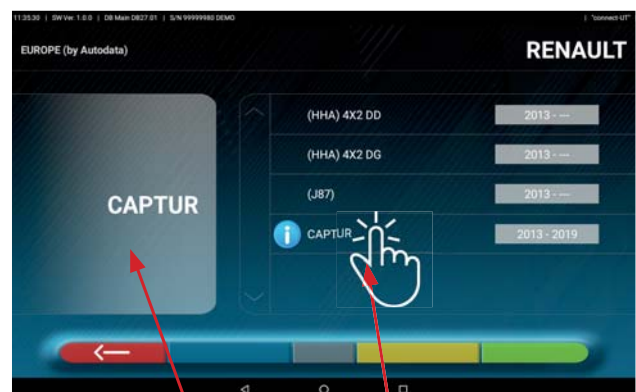

- Figure 32 -

Selected brand

Search by Name/Vin

Selected model

Select the vehicle from the listed models

Pressing key  - Figure 32-, you can select the search method by name.

Type the model name in the box and press the icon , the vehicle or group of vehicles found in the database will be displayed.



- Figure 33 -

Note: if the USA-MOTOR database is present in the device, the search method can be set by “Name” or V.I.N (*) , See - Figure 34.

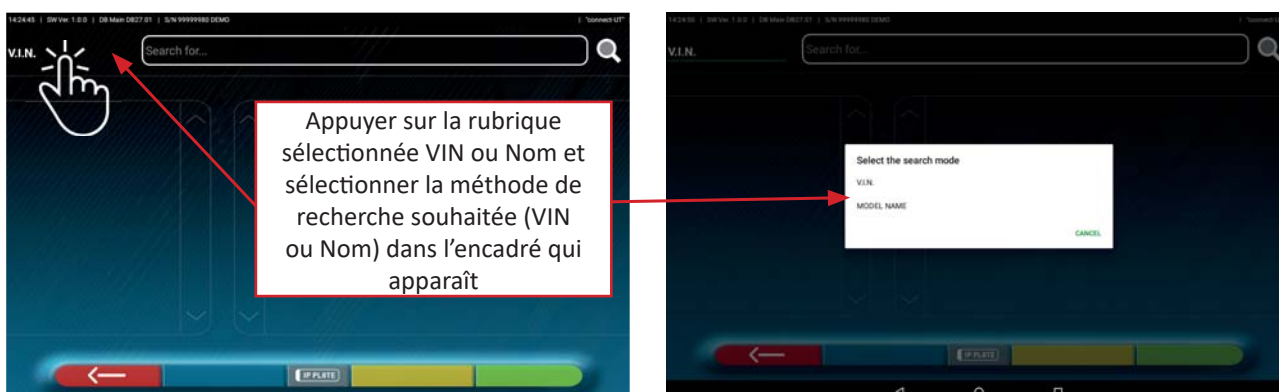

- Figure 34 -

(*) The V.I.N. (Vehicle Identification Number) is a unique serial number used in the automotive industry to identify motor vehicles. It consists of a plate with 17 alphanumeric characters usually located inside the engine compartment.

To set the vehicle selection method “group/brand/model” (- Figure 32-), again, press the central key  in the screen of - Figure 33-.

Note: if the function **SHOOT&GO** enabled, the central key - Figure 33- symbolises a “  ” plate. Press this key to select the vehicle search mode with the Shoot&Go function (See Chap. 6.2 on page 22).

6.2 Search vehicles by license plate number with “SHOOT & GO”



To select the vehicle to be tested, the optional feature **SHOOT&GO** is available that, after entering the license plate number, queries the appropriate web service to identify the right vehicle.



Warning! to use the Shoot&Go feature the Tablet must have Internet access; to this end, for example, you can connect the WAN socket of the Access Point to a data structure with Internet access (See Chap. 4.5).

It is also necessary to ask the manufacturer in advance to enable the function for your country, communicating the serial number of your device (see information on the quick guide code M0335).

If the enabling has been granted, it is necessary, from the configuration menu (See par. 5.1), to set the Shoot&Go

option active in the “Application”  section, moving the switch  to ON (See- Figure 14).

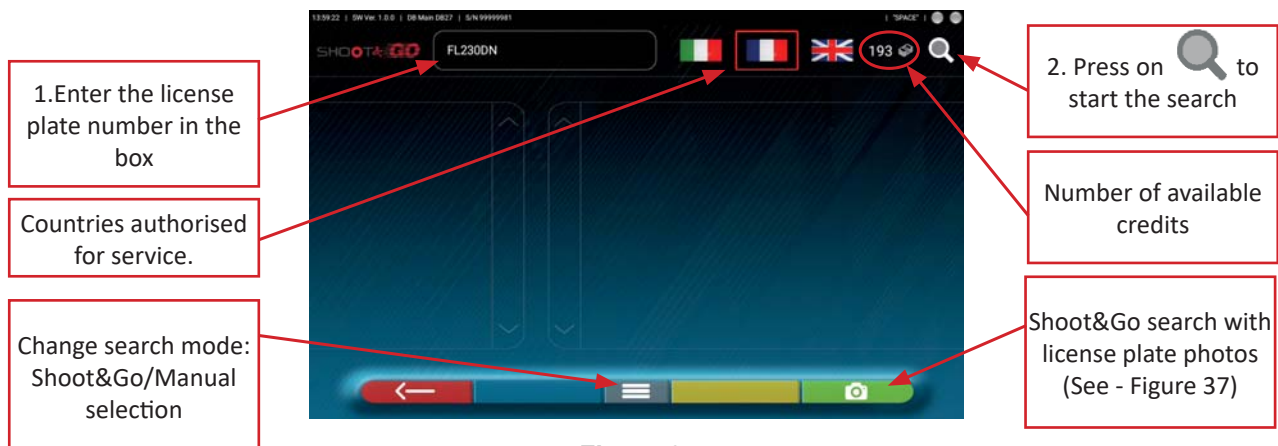

- Figure 35 -

The upper part indicates the countries for which the service was purchased (the selected one is framed, normally only one country is purchased).

The number of available credits (193 in the example) is shown at the top right, close to the icon .

1. Type the license plate number in the box (FL230DN) and 2. at the top left and press the Icon  to start the search. After a few seconds, for the concerned plate, the system shows the vehicle or the group of vehicles identified in the database (See - Figure 36-).



- Figure 36 -

NOTE: If the entered license plate is not present in the central database, the message **“PLATE NOT ACKNOWLEDGED”** appears; if the license plate has been acknowledged but there are no data matched to it, the message **“DATA NOT FOUND”** appears

You can also take a picture of your vehicle's license plate instead of typing the characters manually:
You must activate the Tablet camera by pressing key (See - Figure 35).

Frame the vehicle's license plate inside the box and take the picture by pressing the appropriate key .
Then press the "CONFIRM" button



- Figure 37 -

The license plate photo is processed and acknowledged by the (See - Figure 38).
Press key to start the search for the vehicle with the concerned license plate, the vehicle or group of vehicles identified in the database will appear after a few seconds (See - Figure 36).



- Figure 38 -

6.3 Displaying technical data of the selected vehicle

After having selected the vehicle (See par.-6.1 e-6.2), a screen with the measurements and angle tolerances (minimum, middle and maximum value) and other additional data, such as rim diameter, wheelbase, track width and any loading and tank conditions (*) (- Figure 39-) will appear.

Possible loading and tank conditions

Wheelbase and track width values in mm

Rim diameter:
Note: You can also change the diameter displayed by pressing on the rim symbol.

Front axle angle tolerances
Note: use the scroll bar to view all data

Rear axle angle tolerances

| Parameter | Unit | Min | Middle | Max |
|------------------|------|---------|---------|---------|
| Total toe | mm | -2.24 | -1.12 | +0.00 |
| Camber | Dg | -1.23° | -0.23° | +0.77° |
| Caster | Dg | +4.00° | +5.00° | +6.00° |
| King-pin | Dg | +10.40° | +11.00° | +11.60° |
| Incl.angle | Dg | --- | +10.77° | --- |
| Toe-out on turns | Dg | --- | --- | --- |
| Total toe | mm | +0.53 | +2.18 | +3.83 |
| Camber | Dg | -1.16° | -0.83° | -0.50° |
| Thrust angle | Dg | -0.25° | +0.00° | +0.25° |

- Figure 39 -

The screen with measurements and tolerances can be represented as in - Figure 39-: with a single column of homogeneous values for the left and right sides.

In the "Settings" menu (See- Figure 15 on page 14) it is also possible to set the displaying of data separated between left and right sides (some vehicles may have slightly different tolerance values for left and right sides).

By pressing key it is also possible to display the measurements with the middle value and the total tolerance "±" (See - Figure 40).

Press key to display alternately
- min/middle/max
- middle/tolerance "±"

| Parameter | Unit | Min | Middle | Max |
|------------------|------|---------|--------|-----|
| Total toe | mm | -1.12 | 1.12 | --- |
| Camber | Dg | -0.23° | 1.00° | --- |
| Caster | Dg | +5.00° | 1.00° | --- |
| King-pin | Dg | +11.00° | 0.64° | --- |
| Incl.angle | Dg | +10.77° | --- | --- |
| Toe-out on turns | Dg | --- | --- | --- |
| Total toe | mm | +2.18 | 1.65 | --- |
| Camber | Dg | -0.83° | 0.33° | --- |
| Thrust angle | Dg | +0.00° | 0.25° | --- |

- Figure 40 -

Press key to continue with the preliminary operations on the vehicle (See -par. 6.4 on page 28)



(*) The device with the CCD2.0WiFi APP contains vehicle technical information provided through official databases. Access to the system and information is subject to reading and accepting a Disclaimer, which is shown on the device after the first start of the APP.

6.3.1 Displaying ADDITIONAL MEASUREMENTS on CHASSIS HEIGHTS

Some manufacturers (e.g. Mercedes, Renault) provide the angle tolerance values according to particular measurements on the vehicle chassis.

When the selected vehicle has angle tolerance values linked to additional measurements on the chassis, key is present on the technical data page (- Figure 41-). Press the key to display the page with details on chassis measurements.

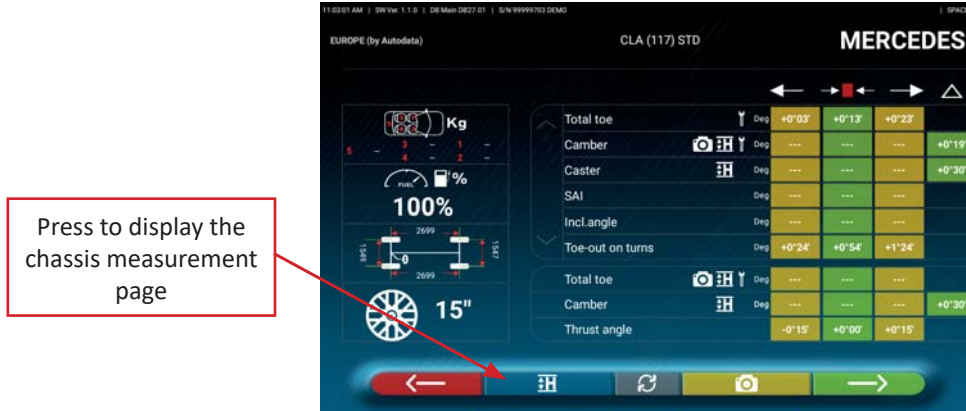

- Figure 41 -

The program displays a page as in the example of - Figure 42- , use the scroll bar to view the different images, press on an image to enlarge it.

Scroll through the different heights/angles in the tables and select the correct values.

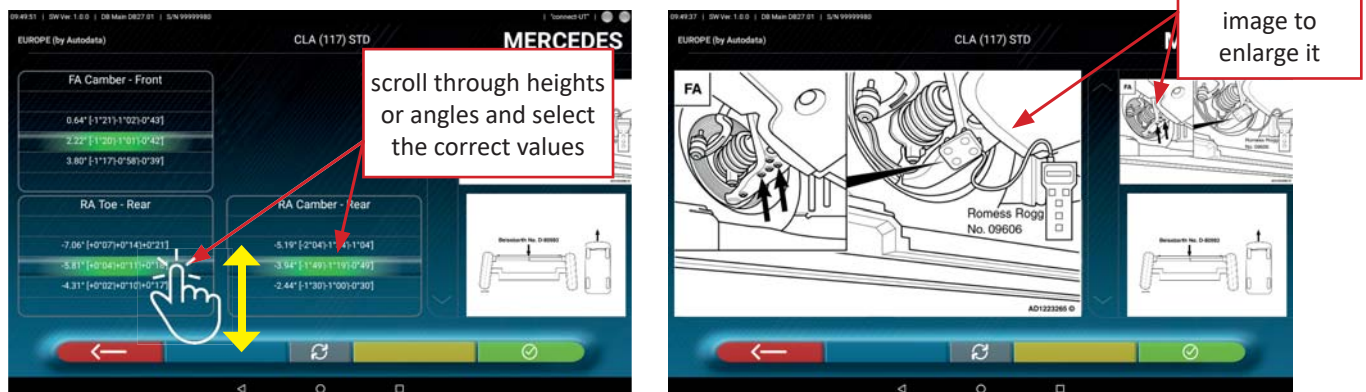

- Figure 42 -

The measurements can be entered by selecting them from the tables, as in the example above - Figure 42- , or by pressing key a page is displayed, as in the example above - Figure 43-, where you can directly enter the values.

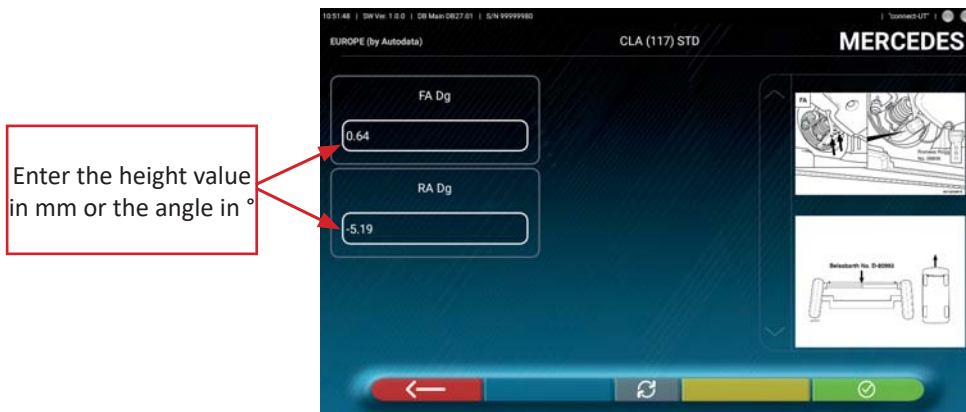

- Figure 43 -

Press key to confirm the entered values

6.3.2 Displaying CHECK MEASUREMENTS on CHASSIS HEIGHTS

Some manufacturers (e.g. Citroen, Peugeot) provide tolerance values for particular measurements on the vehicle chassis (check values).

When the selected vehicle has tolerance values with check values, key is present on the technical data page (- Figure 44-) Press the key to display the page with the details of the check values.



Press to display the page with the chassis check values

- Figure 44 -

The program displays a page as in the example of - Figure 45, use the scroll bar to view the different images, press on an image to enlarge it.

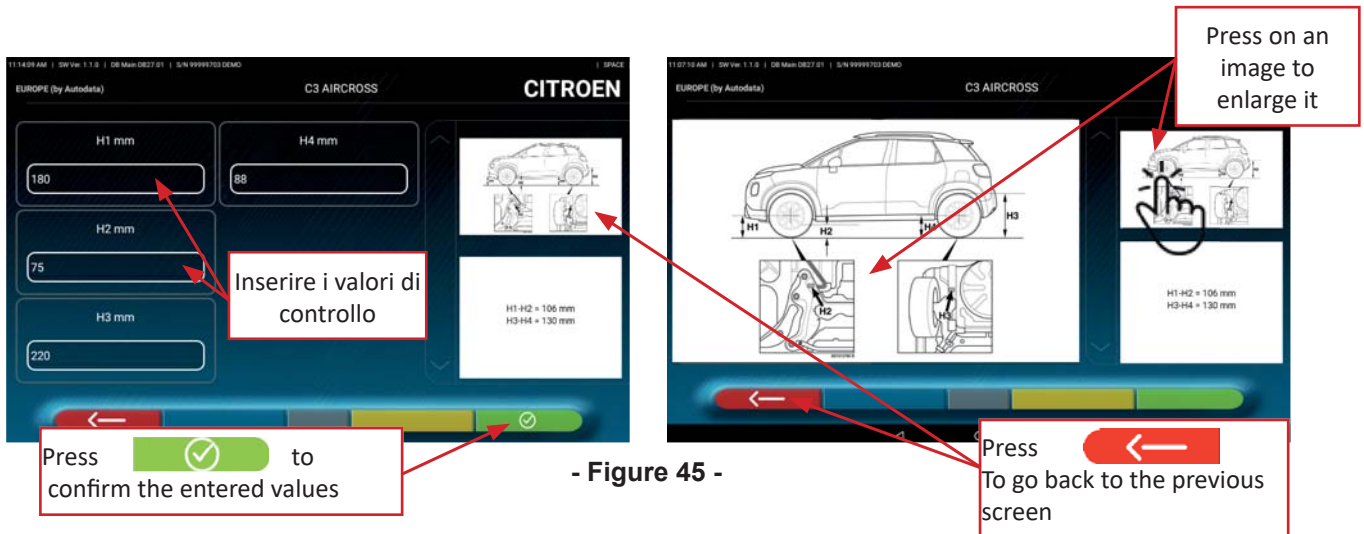

Inserire i valori di controllo

Press to confirm the entered values

Press on an image to enlarge it

Press To go back to the previous screen

- Figure 45 -

Enter the check values directly, and press key to confirm the entered values.

6.3.3 Displaying ADJUSTMENT HELP images

For several vehicles of some manufacturers, adjustment help images are available, which indicate how to adjust the different angles of the vehicle, such as front axle camber and caster angles or rear axle camber and total toe.

When the selected vehicle has adjustment help images, the technical data page (- Figure 46-).includes key .

 Press the key to display the adjustment help images.

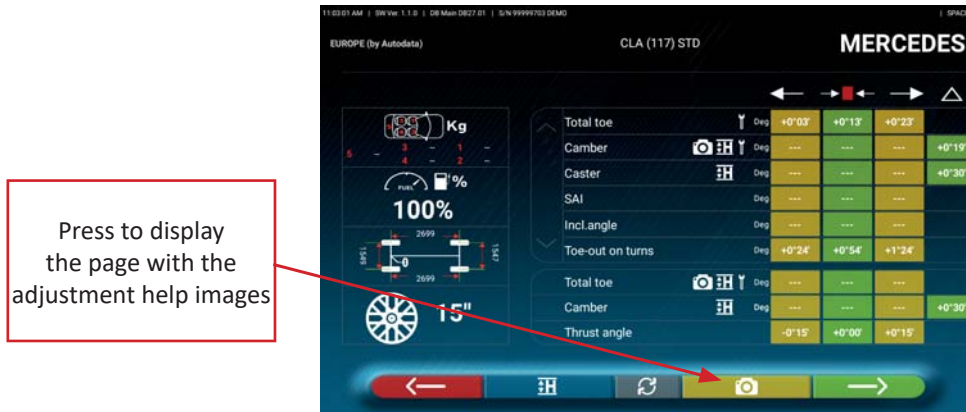

- Figure 46 -

The program displays a page as in the example of - Figure 47-, use the scroll bar to view the different images, press on an image to enlarge it.

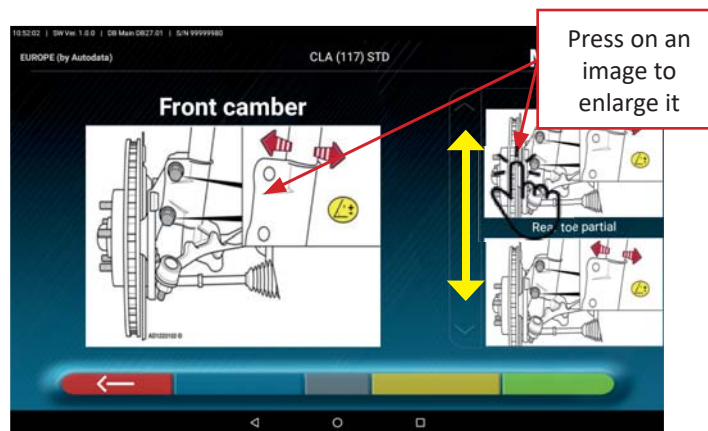

- Figure 47 -

Press key  to go back to vehicle's technical data page.

Note: also during the rear or front adjustment (par. 6.11 on page 33 and par. 6.12 on page 34), if there are adjustment help images, key  is available to view them if necessary.

6.4 Preliminary operations

6.4.1 Preliminary vehicle inspection operations

Before checking vehicle wheel alignment, a few preliminary checks must be performed:

- Check and, if necessary, eliminate any play on the suspensions and steering linkage.
- Check and, if necessary, eliminate any hardening or yielding of the suspension flexible components.
- Adjust the tyre pressure to the values prescribed by the manufacturer.
- Position and distribute any loads foreseen by the manufacturer

6.4.2 Run-Out preparation

After displaying the vehicle technical data (See par. 6.3 on page 24) press on key to continue, the page showing the preparation of - Figure 48- Figure 48 the vehicle for the Run-Out procedure will be displayed:

- Lock the turntables
- Position the vehicle with the front wheels on the turntables
- Fit clamps and detectors on the wheels

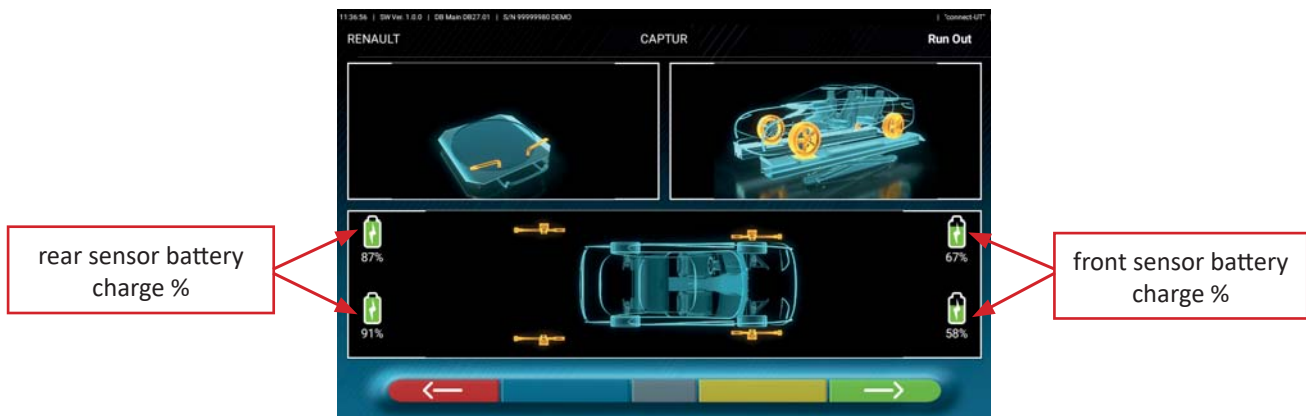

- Figure 48 -

Note: in this step, images representing the 4 sensor batteries - with relevant remaining charge % are displayed.

6.5 Run-Out

The Run-Out procedure is carried out to compensate for any deviation between the plane passing through the wheel and the one actually measured.

This procedure can however be skipped, when required, with key (See - Figure 49-).

6.5.1 Push Run-Out procedure with automatic acquisition

In the Run-Out preparation phase (See par. 6.4.1 on page 28) select key . The following screen appears.

To perform the Run-Out operation, always follow the visual instructions on the screen.

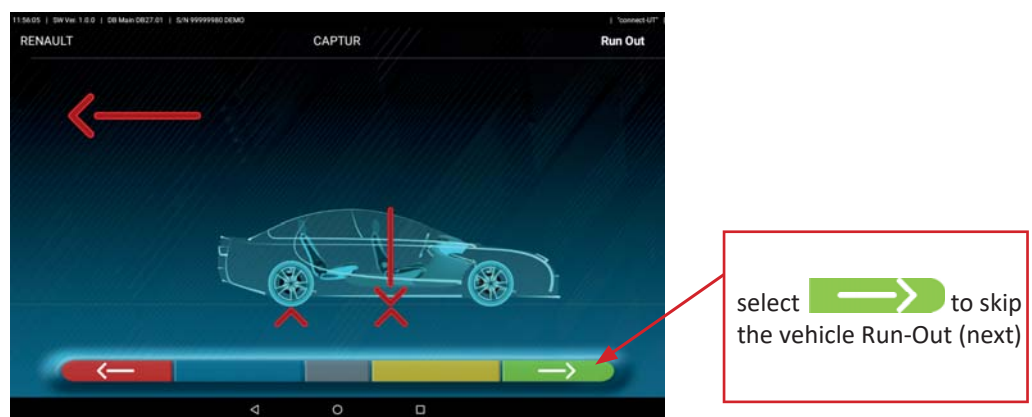

- Figure 49 -

UNLOCK the detectors using the appropriate knob (See - Figure 6) so that they are free to rotate and allow for vehicle movement. Move the vehicle backwards, very slowly, until the arrow on the vehicle reaches the target point.

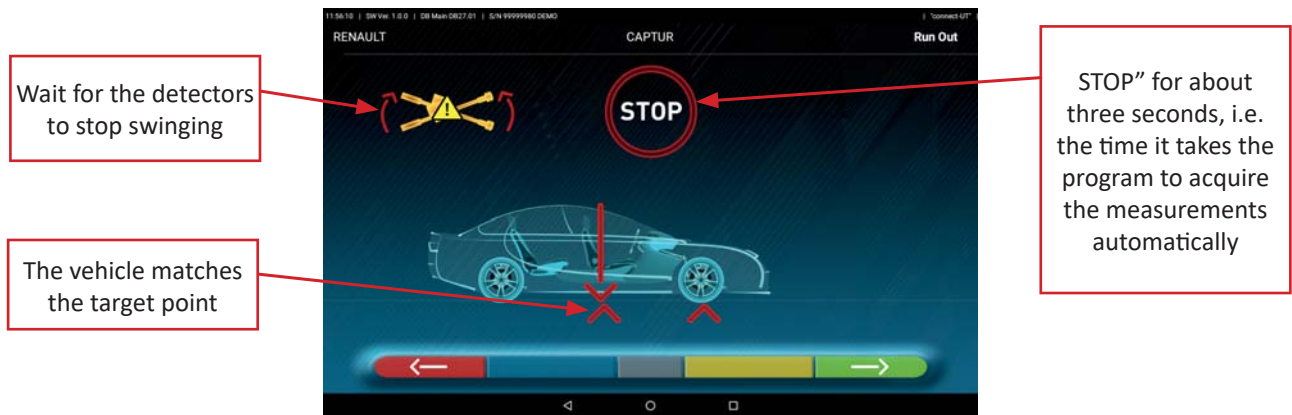

- Figure 50 -

As soon as the vehicle is aligned with the target point, wait for the detectors to stop swinging, "STOP" is displayed for about three seconds, which is the time it takes the program to acquire the measurements. Then the program displays the following screen:

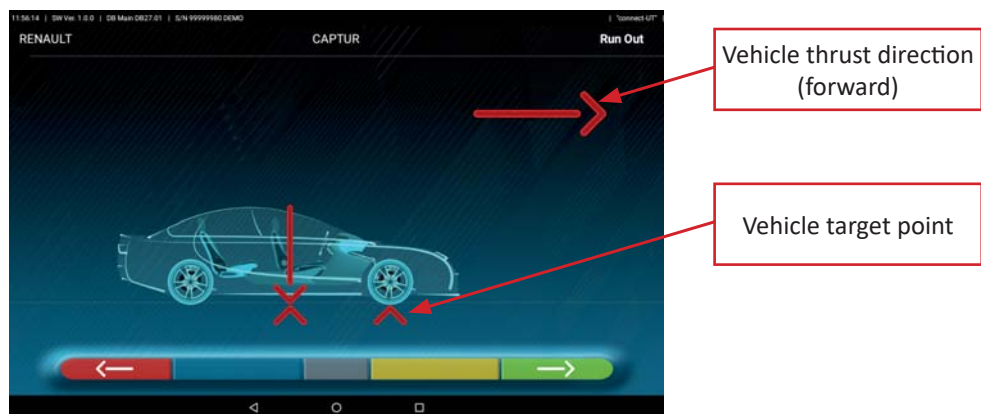

- Figure 51 -

Move the vehicle forward again, until the arrow on the vehicle matches the target point (end point), "STOP" is displayed for about three seconds, measurements are acquired. The Push Run-Out procedure has been performed.



- Figure 52 -

When the Run-Out has been performed, the program automatically continues to the next step: Measurement preliminary operations (par. 6.6 on page 30).

6.6 Measurement preliminary operations

After performing the Run-Out procedure, as explained in par. 6.5 on page 28, it is necessary to prepare the vehicle for measurements. The following screen will appear:

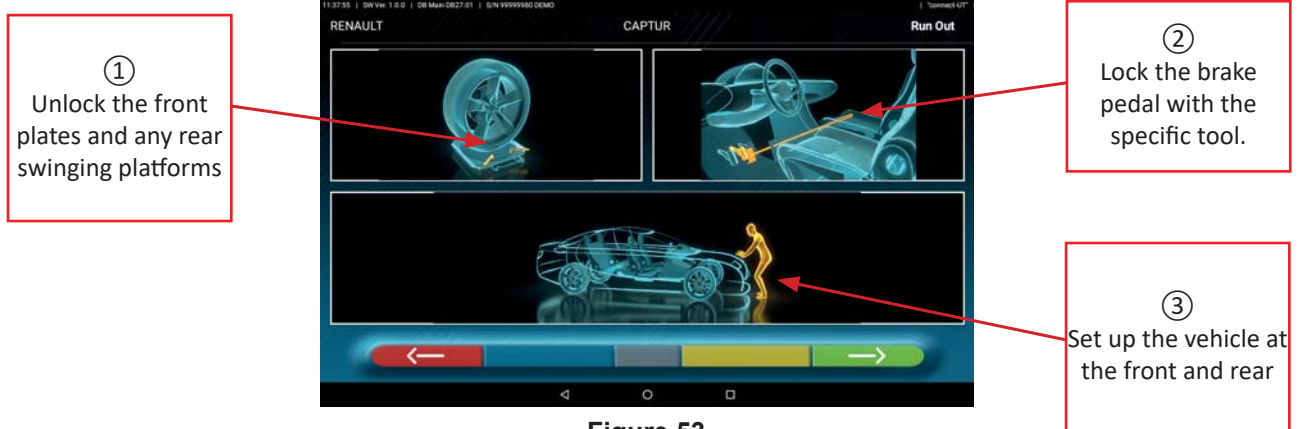

- Figure 53 -

- 1) Unlock the front plates and any rear platform
- 2) Brake the wheels with the handbrake and lock the brake pedal with the specific tool (in case of steering, this is necessary to correctly calculate the steering axis inclination and caster angles).
- 3) Set up the vehicle at the front and rear. This operation is necessary if the vehicle has been previously lifted with the suspension released (e.g. running Run-Out with raised wheels).

Press key to go back to the Run-Out run-out procedure (par. 6.5 on page 28)

Press key to continue with the alignment (par. 6.7 on page 30).

6.7 Aligning and levelling detectors

After having carried out the preparation for the measurements as explained in par. 6.6 on page 30, the screen of - Figure 54-; will be displayed; the alignment and levelling procedure of the detectors must be carried out:



- Figure 54 -

Turn the steering wheel from left to right, or vice versa, until the wheels are aligned, i.e. until the display level appears at the centre;

Adjust the detectors until they are levelled and brake them using the suitable knobs. This operation must be performed for all four detectors.

After the detectors have been aligned and levelled, a "STOP" signal image appears, indicating that the program is taking measurements, then the program continues automatically.

WARNING: The vehicle on which operations are being carried out may be equipped with a front Spoiler preventing the detectors from communicating with each other. In this case the special "spoiler" procedure is automatically started.

(See par. 6 on page 20).

6.8 Steering procedure

After performing the alignment and levelling procedure on detectors (See par. 6.7 on page 30), the screen of - Figure 55 ; appears, in which you can carry out the steering procedure, which is used to determine the angle measurements relating to:

- Caster angle- King pin- Included angle

Following the directions on the screen, turn the steering wheel to bring the level of the display to the target point highlighted in green, first to the left, then to the right and finally to the centre.



After the wheels have been moved back to the centre, the program will continue automatically and will show the diagnosis page. (par. 6.9 on page 32).

Note: The steering procedure can also be skipped by selecting key  The values of the above mentioned measurements will not be displayed and the diagnosis page will be directly displayed (par. 6.9 on page 32).



- Figure 55 -

(*) Steering mode for acquisition of Caster angle/king pin

-  → 10° steering
-  → 20° steering
-  → ACKERMANN steering (20° with steering geometry)

(**) Maximum steering:

Selecting key , the page on the side appears (- Figure 56-), where it is possible to manually enter the maximum steering values that are used to evaluate the centring of the steering box. These must be read on the turntable graduated scale(- Figure 11 on page 12).

After entering the values confirm with

key .

The maximum steering values will be reported on the final print report.



- Figure 56 -

6.9 Vehicle Diagnosis

After having carried out the steering procedure (See par. 6.8 on page 31), a page showing the summary of the measurements made (- Figure 57 on page 32).

The factory reference values are indicated on the left, while the right side shows the diagnosis measurements; the values are highlighted in green if within tolerance, in red if out of tolerance, in grey if the tolerances are not present.



- Figure 57 -

Press key to go back to the procedure steering procedure (par. 6.8 on page 31).

Press key to access the vehicle and customer data entry phase (See- Figure 66 on page 37)) from which it is possible to print (See par. 6.14 on page 37), share the measurements made (par. 6.15 on page 40) or, if necessary, save the tests (if TEq-Link is present See par. 6.16 on page 41).

Press key to display the chassis diagnosis page (par. 6.13.1 on page 36).

Press key to continue with the adjustment preliminary operations (par. 6.10 on page 32).

6.10 Adjustment preliminary operations

Selecting key from the diagnostic measures summary page (par. 6.9 on page 32), a page showing the adjustment preliminary operations will be displayed. Follow the instructions on the device to complete the adjustment preliminary operations:

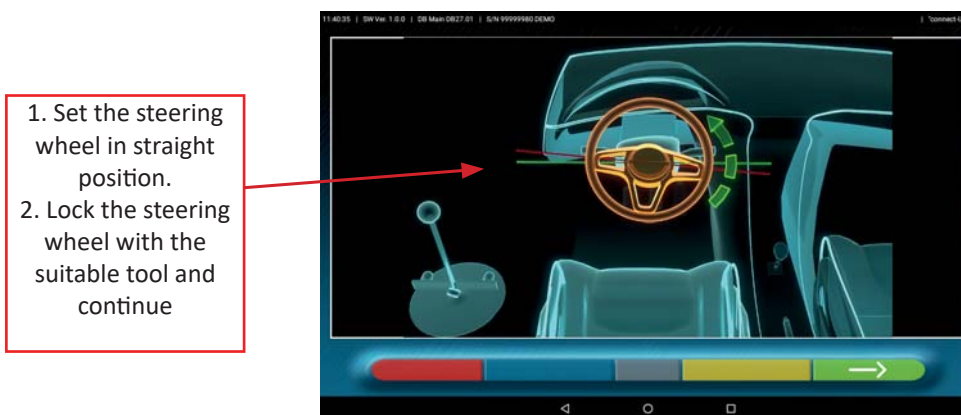

- Figure 58 -

Press key to continue with the adjustment of the rear axle (par. 6.11 on page 33) .

6.11 Adjusting the rear axle

The rear axle adjustment procedure can be accessed by pressing key  of - Figure 58, after having carried out the adjustment preliminary operations (par. 6.10 on page 32).

Adjust, where permitted, in the following order:

Rear inclination- Rear partial toe (this also determines the thrust angle).





- Figure 59 -

Press key  to perform the “Jack-Hold” procedure with the wheels raised (6.12.1 on page 35).

If there are adjustment help images (par. 6.3.3 on page 27), press key  to display them.

Press key  to continue the adjustment of the front (par. 6.12 on page 34).

NOTE: If you have configured the “adjustment by sound” function in the “  Application “ menu (See Chap.5.1 on page 13- Figure 14 on page 14),), click on the desired angle, the indication “  ” will appear below it and a “Beep” will be emitted with a variable frequency based on the value itself.

Beep with very slow frequency → value out of tolerance

Beep with slow frequency → value close to tolerance

Beep with fast frequency → value within tolerance

Continuous beep → *exact tolerance middle value*

Click on the angle again to cancel the indication  and deactivate the “Beep”.

6.12 Adjusting the front axle

The front axle adjustment procedure can be accessed by pressing key on the rear axle adjustment page (- Figure 59) and after having carried out the adjustment preliminary operations (See par. 6.10 on page 32). The recommended order of the angles to be adjusted is as follows: CASTER- CAMBER- TOTAL TOE.

WARNING: The caster values, entering this phase, are “FROZEN” and displayed in grey.

To “UNFREEZE” the above mentioned values: press on the “Caster” values; the symbols “>” “<” appear and key is displayed at the bottom; pressing on this key will make the values become Red or Green (according to the tolerance) and the cursor “

Once the caster values have been adjusted, or even if they are not adjusted and deemed to be correct, it is advisable to “RE-FREEZE” the above values by pressing on the same key .

Then adjust the front axle



- Figure 60 -

Press key to perform the “Jack-Hold” procedure with the wheels raised (6.12.1 on page 35)

If there are adjustment help images (par. 6.3.3 on page 27), press key to display them.

Press key to continue to the summary of DIAGNOSIS and ADJUSTMENT data (par. 6.13 on page 36).

6.12.1 "Jack-Hold" procedure

From the measurement adjustment page (See- par. 6.11 e 6.12) press key to perform the JACK-HOLD procedure.

Follow the visual instructions shown on screen.

Lift the vehicle

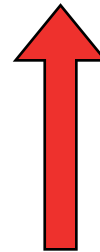
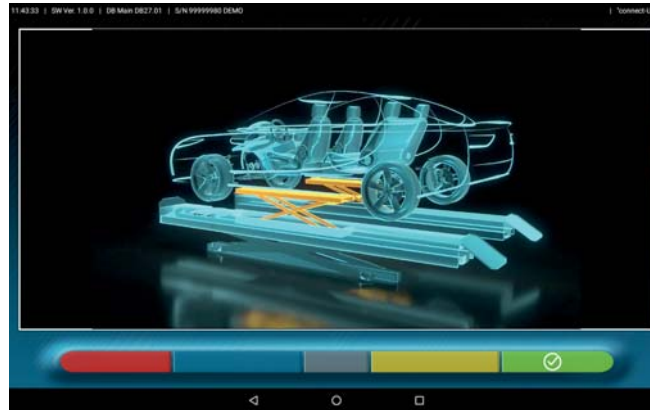
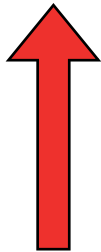

- Figure 61 -

When the vehicle is lifted press key to confirm the lifting of the vehicle;

Now, with the vehicle lifted, it is possible to perform the adjustment.

Press key to switch from the rear to the front adjustment and vice versa;



- Figure 62 -

At the end of the adjustment, press key to lower the vehicle and confirm with key when it is correctly resting on the platforms.

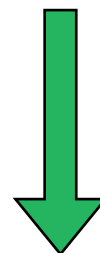
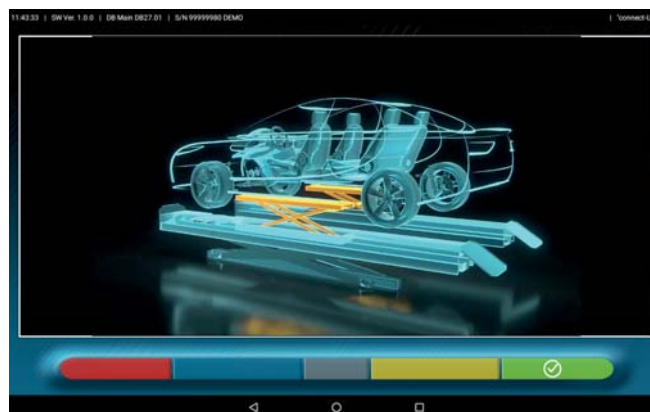
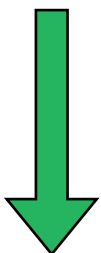

- Figure 63 -

At this point of the adjustment, the program displays again- Figure 60 (See par. 6.12 on page 34) press key to display the final summary (par. 6.13 on page 36)

6.13 Summary of DIAGNOSIS and ADJUSTMENT data

When the front adjustment phase on the vehicle has been completed (See - Figure 60 on page 34), after pressing key , the Diagnosis and Adjustment data summary page appears - Figure 64.

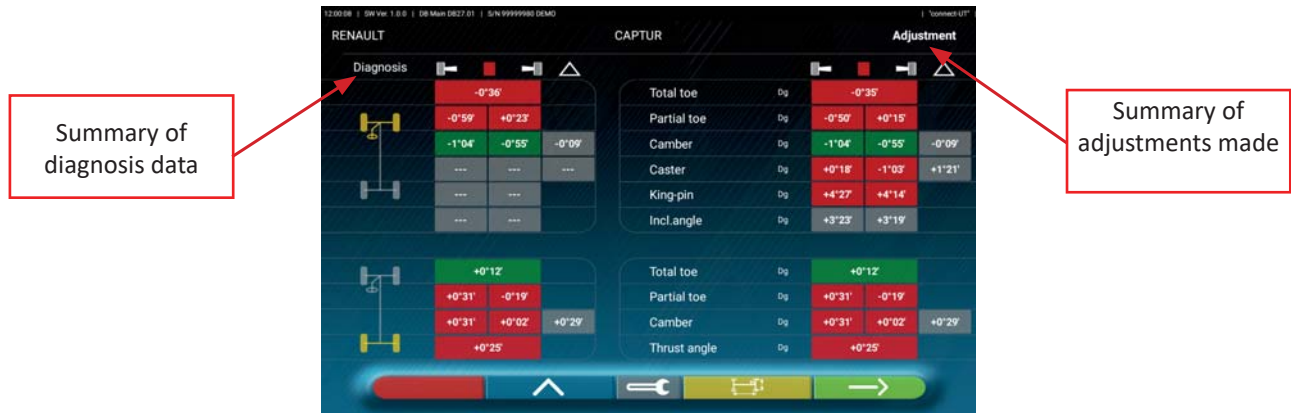

- Figure 64 -

Press key  to access the vehicle and customer data entry phase (See- Figure 66) from which it is possible to print or share the measurements taken (See par. 6.14 on page 37) and, if necessary, save the tests (if TEq-Link is present - See par. 6.15 on page 40).

By pressing key , the program goes back to the preliminary operations phase (par. 6.4 on page 28).

Note: if significant adjustments have been made, it is advisable to repeat the diagnosis phase starting from the preliminary operations in order to correctly recalculate the angle measurements.

Press key  to display the chassis diagnosis page (par. 6.13.1 on page 36).

Press key  to go back to the rear adjustment phase (par. 6.11 on page 33).

6.13.1 Chassis diagnosis

In the Diagnosis data summary page (par. 6.9) and in the Diagnosis and Adjustment summary page (par. 6.13) by pressing key , a page is shown with the graphic representation of the vehicle with the set-back measurements (axle toe-out) for the front and rear axles.



- Figure 65 -

This measurement is carried out during vehicle alignment phase (See par. 6.7 on page 30).

Press key  to quit and go back to the previous phase.

6.14 Printing the measurements made

Select key  on the test summary page (See 6.13 on page 36), to show the following screen, where you can enter vehicle and customer data:

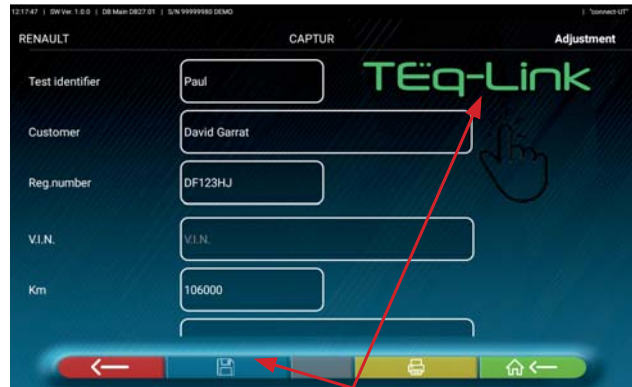
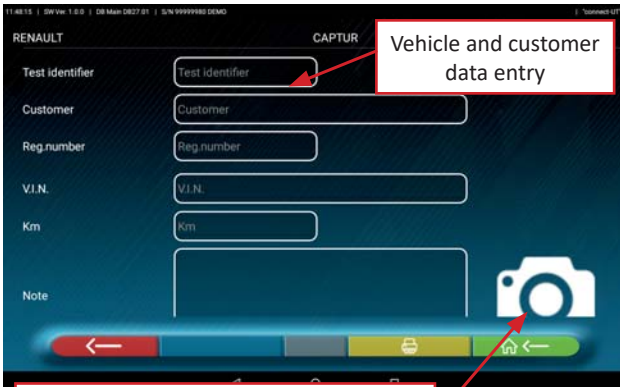

Possibility to insert photos of the vehicle by pressing on the icon 

- Figure 66 -

The test can be saved if the TEq-Link function is configured (See - par. 6.16)

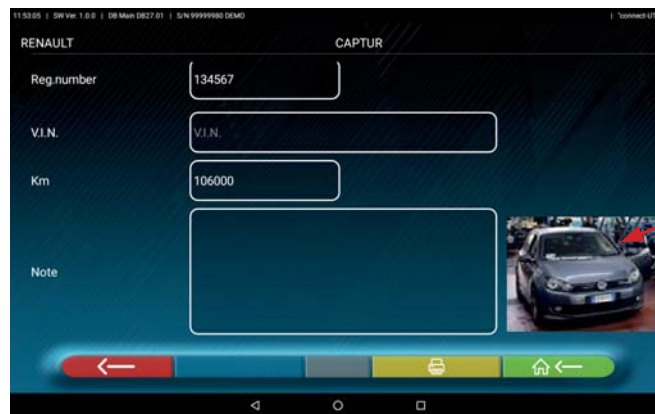





Photo also included in the print

- Figure 67 -

Press key  if you want to go back to the front axle adjustment phase (par. 6.12 on page 34). Press key  to display the print preview of the test performed (See- Figure 68); the report is available in two formats (graphic or table- see examples on the following pages) configurable in the "PRINT" menu (See- Figure 64 on page 36); Press key  again to issue the report (*).



Print preview

Note: If graphic printing is set, two pages are generated, one with Diagnosis values and the other with Adjustment values

- Figure 68 -

Press key  from the page - Figure 67, to end the test and go back to the home page.

(*) The printer is not supplied with the CCD2.0WiFi system. You can still use generic Android or iOS compatible WiFi printers, and you can connect to the "connect" WiFi network of the Access Point provided (See - par. 4.5).

If you do not have a printer, you can save the .pdf file of the test locally and export it later.

6.14.1 Example of table printing

Vehicle and customer data
Date/time

25/11/2019 12:14

Space reserved for workshop data
customisation

| | | | |
|---------------------|--------------|-------------------|--------|
| Customer | David Garrat | Km | 106000 |
| Reg. number | DF123HJ | Rim diam. | 15" |
| Vehicle make | RENAULT | Chassis n. | CAPTUR |

| | | | | | | | |
|-----------------|-----------------|------------------|---|------------------|---|-------------------|---|
| SW Ver. | 1.0.0 | FL → FR → | △ | Diagnosis | □ | Adjustment | △ |
| FW | | RL → RR → | → | | | | → |
| Database | DB Main 0827.01 | | | | | | |

| | Nominal values | | Diagnosis | | Adjustment |
|------------------|----------------|-----|-----------|-----|------------|
| Total toe | dg -0°20' | ← → | -0°04' | → ← | -0°05' |
| Partial toe | dg -0°10' | ← → | -0°15' | → ← | -0°07' |
| Camber | dg -1°14' | ← → | -1°06' | → ← | -1°06' |
| Caster | dg +4°00' | ← → | +0°17' | → ← | +0°17' |
| King-pin | dg +10°24' | ← → | +4°23' | → ← | +4°23' |
| Incl. angle | dg --- | ← → | +3°17' | → ← | +3°17' |
| Toe-out on turns | dg --- | ← → | --- | → ← | --- |
| Steering in | dg --- | ← → | --- | → ← | --- |
| Steering out | dg --- | ← → | --- | → ← | --- |
| Total toe | dg +0°02' | ← → | +0°39' | → ← | +0°39' |
| Partial toe | dg +0°02' | ← → | +0°31' | → ← | +0°31' |
| Camber | dg -1°10' | ← → | +0°31' | → ← | +0°31' |
| Thrust angle | dg -0°15' | ← → | +0°11' | → ← | +0°11' |

Factory default values of
the vehicle under test

Values measured during
diagnosis

Measured values after
adjustment phase

vehicle identification photo
(if taken)

- Figure 69 -

6.14.2 Example of graphic printing

ALIGNER CCD2.0WiFi

Space reserved for workshop data customisation

| | | | |
|------------|------------------|---------------------------|----|
| Customer | David Garrat | Vehicle and customer data | |
| Vehicle | RENAULT CAPTUR | Date/time | |
| Date | 26/11/2019 12:23 | Chassis n. | |
| Reg.number | DG345JT | VIN | |
| Km | 106000 | Rim diam. | 15 |



vehicle identification photo (if taken)

Graphical representation of the wheel according to tolerance values

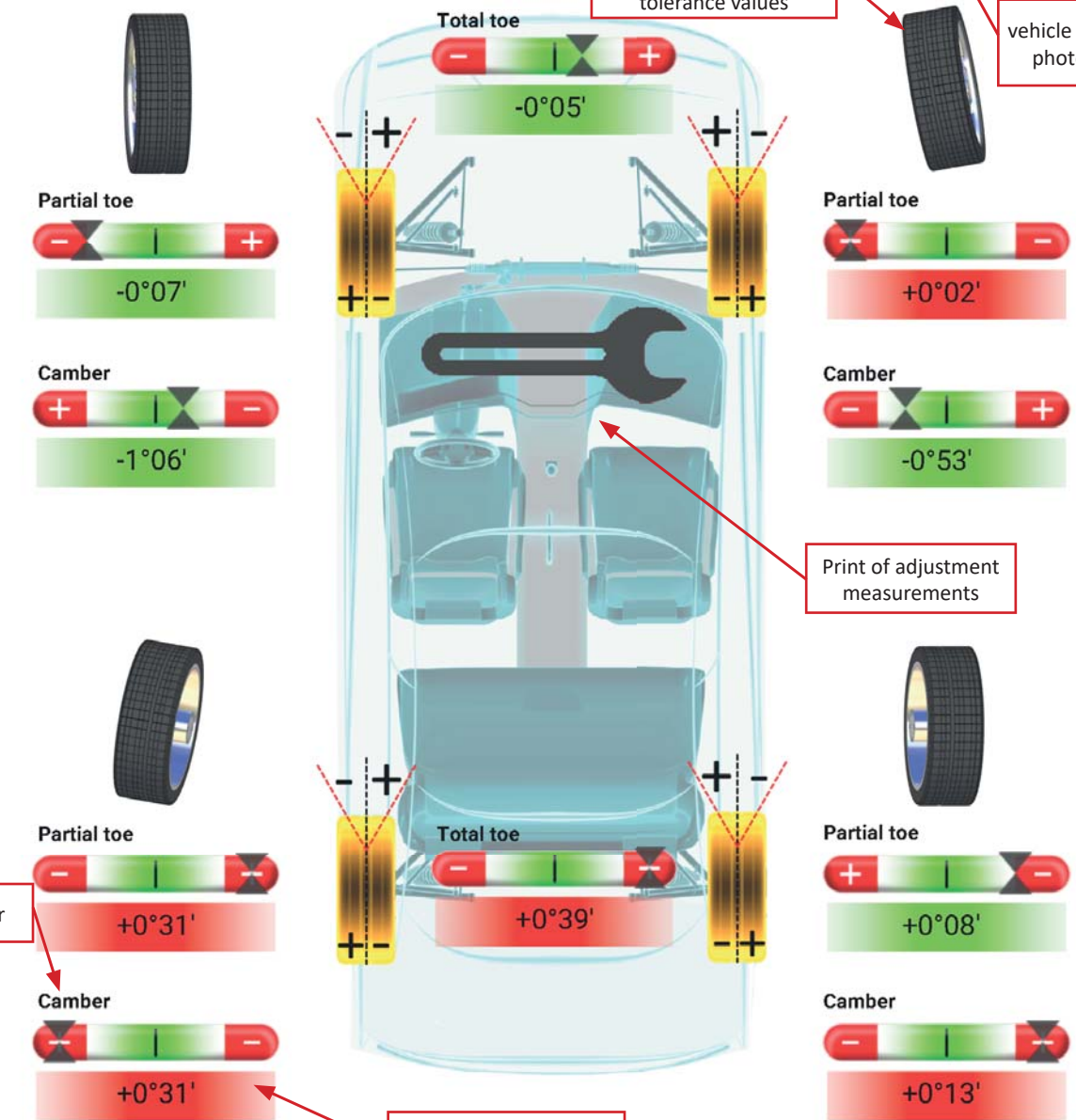

Print of adjustment measurements

Tolerance bar

Value indicated in red / green depending on whether or not it is within tolerance

SW Ver. 1.0.0
Fw FL - FR - RL
Database DB Main DB27.01



- Figure 70 -

6.15 Sharing the test carried out

At the end of the test it is possible to share, for example via e-mail, the report with the results and all vehicle data.

 **Warning!** To share via E-Mail, the Tablet must have Internet access; for example, the WAN socket of the Access Point can be connected to a data structure with Internet access (See Chap. 4.5).

After previewing the print page (See- Figure 68), press key  , a window with the possible sharing options will appear (See- Figure 71).

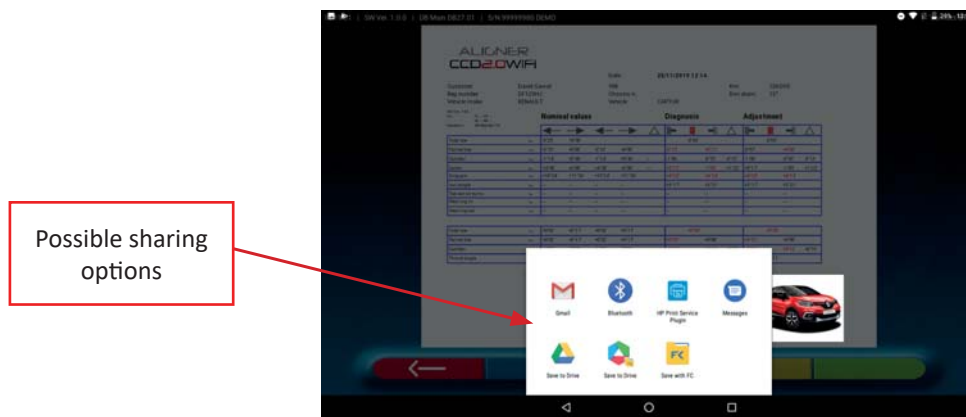

- Figure 71 -

Select the sharing method; in this example  "E-MAIL"

Write the recipient's email address and press the "Send" button 

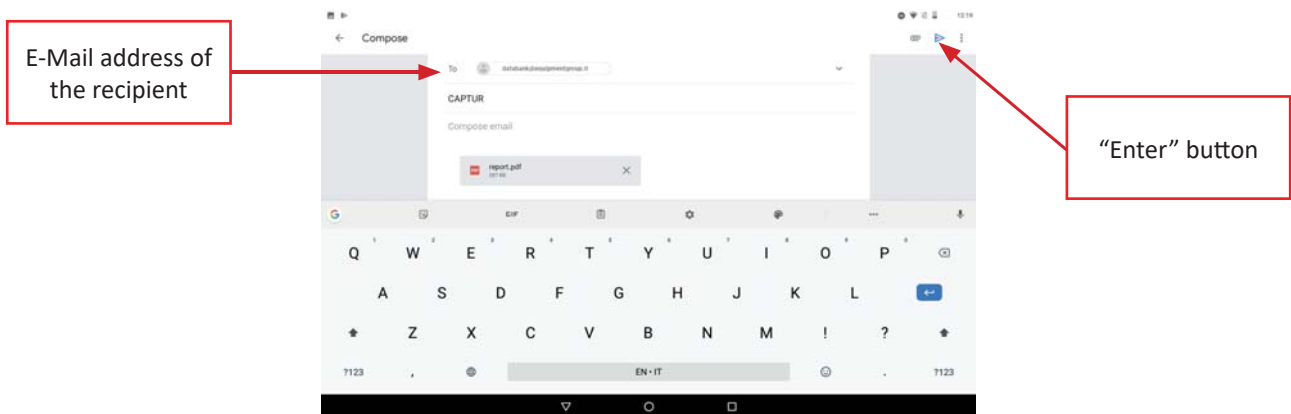

- Figure 72 -

The print report file is sent in .pdf format.
After sending the email, the print preview page (- Figure 68) is displayed again.

6.16 Saving the tests performed with TEq-Link

At the end of the test it is possible to save the report with the results and all the data related to the vehicle, through the function **TEq-Link**.

It is necessary to install the “TEq-Link Web Manager” software in a Personal Computer connected to the workshop computer network and connect the Tablet to the same data structure, for example by connecting the Access Point to a network socket shared with the PC where the “TEq-Link Web Manager” SW software is installed (See Chap. 3.5; see also references on the quick guide code M0335).

Warning! *It is necessary to ask the manufacturer to enable the function in advance, communicating the serial number of your device (see information on the quick guide code M0335) and configure the App with the references of the PC where the software “TEq-Link Web Manager” is installed (See par. 6.16.1 on page 41).*

After finishing the test, during the customer data entry phase (See- Figure 66 on page 37), you can save the test results using key .

When the tests performed are stored, their results become immediately accessible from any PC or mobile device in the network shared with the Tablet.

6.16.1 Configuring the TEq-Link function

Before saving the test with TEq-Link function, you must first enter the references of the PC where the “TEq-Link Web Manager” software is installed.

Access from the configuration menu (See- par. 5.1)) to the “Application”  settings and select the option **TEq-Link**

Then enter the IP address of the PC where the “TEq-Link Web Manager” software is installed, or enter the name of the PC it self See- Figure 73.



Enter the I.P. Address or PC name with the SW “TEqLink Web Manager”

- Figure 73 -

From any PC or mobile device in the same network, by simply entering the I.P. or the name of the PC with the SW “TEqLink Web Manager”, in the address bar of the browser you can access the main page for the management of saved tests; see example in - Figure 74.

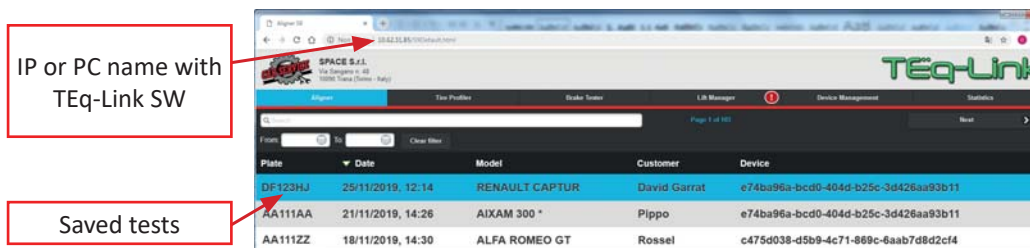

IP or PC name with TEq-Link SW

Saved tests

- Figure 74 -

Note: the same page also opens on the Tablet by clicking on key  on the application’s home page (See - Figure 30).

7 FRONT AXLE SPOILER PROCEDURE

During alignment and levelling operations on detectors (See par. 6.7 on page 30), it could happen that a vehicle, equipped with a front spoiler, prevents front detectors from taking the measurement with the alignment transducers at the end of the arm (See- Figure 6 on page 9).

If the measurement is prevented, the problem is automatically detected and managed by the program, which shows the following screen:

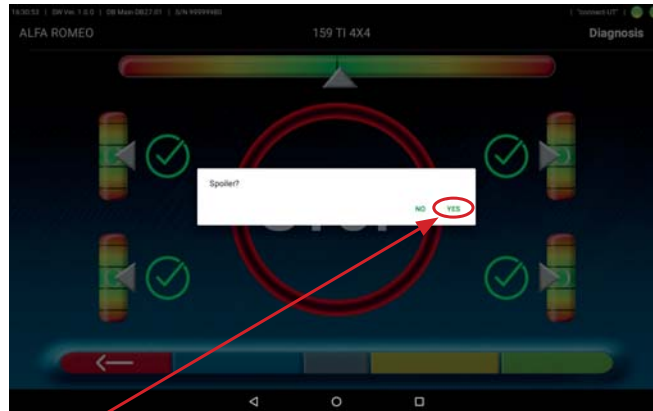

- Figure 75 -

Press YES to start the Spoiler procedure (See- Figure 75).

Attention: Sometimes the Spoiler procedure can be required even when there is no obstacle between front detectors, but the latter still cannot take any measurement because values are outside the maximum range of $\pm 2.50^\circ$.
E.g.: the vehicle is crashed and no pre-adjustment was performed.
In this case, it is possible to display a page showing the alignment angles by pressing key .

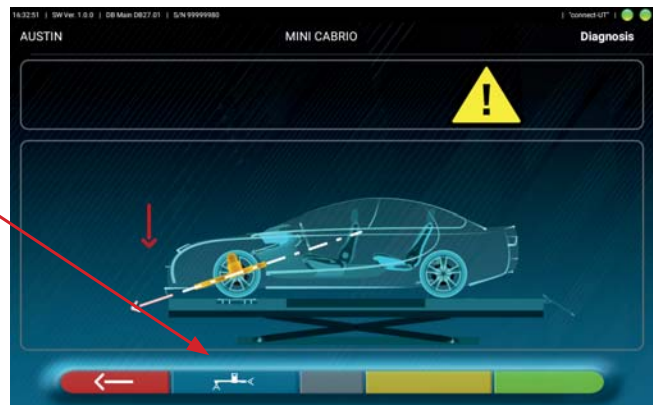

- Figure 76 -

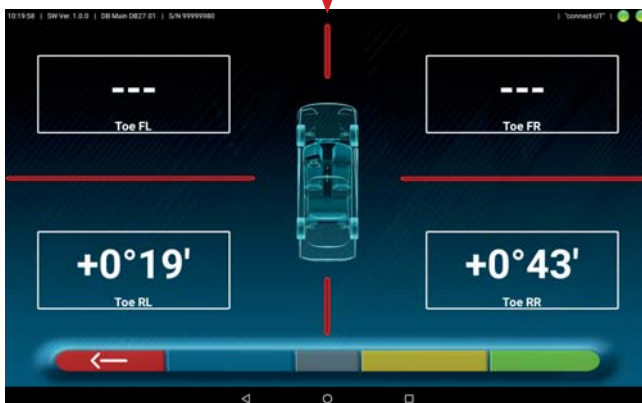

In this case, adjust the front alignment values possibly to around 0° . After having obtained valid values ($<2.5^\circ$), press key  to repeat the alignment step (see chap. 5.7); the spoiler procedure will not be necessary if the program moves on to the next step (See - Chap. 6.8).

A graphic representation of the procedure is shown (- Figure 77): The arrow indicates that the front left detector must be unlocked and lowered as much as necessary for the transducer at the end of the arm to be below the spoiler. Brake the detector again. The central key of the detector keypad displayed on screen will start flashing to indicate that it must be pressed on the concerned detector to continue the procedure.

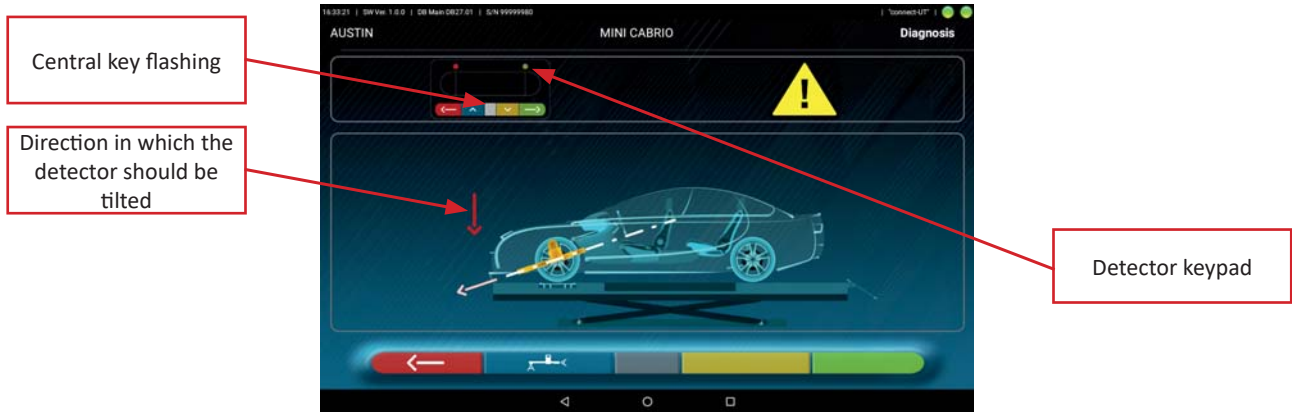

- Figure 77 -

The following screen is displayed when the key is pressed:

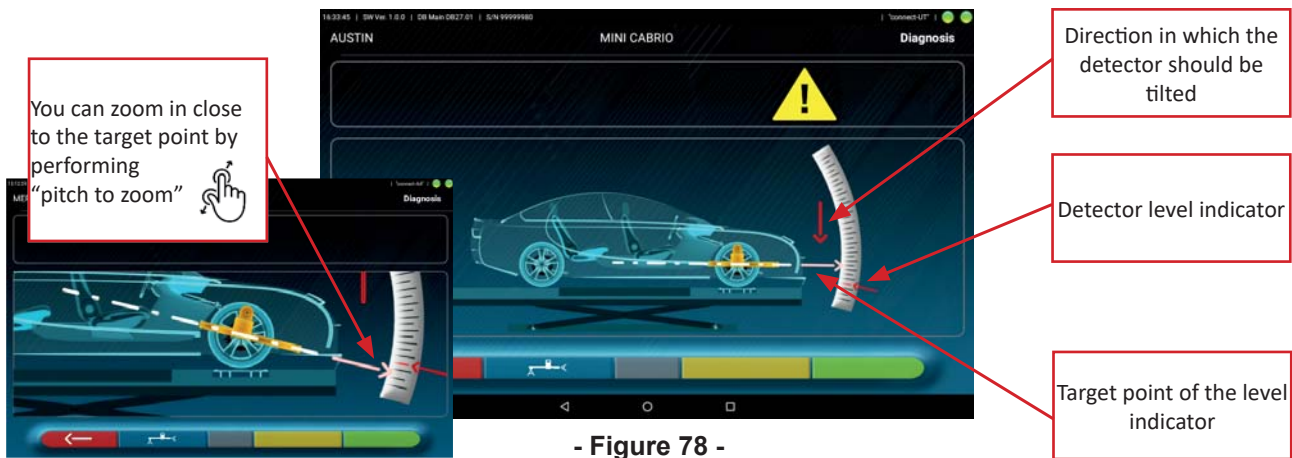

- Figure 78 -

At this point, the front right detector must be unlocked, lowered, until the level indicator is perfectly aligned with the target point, and then locked again.

The following screen will be displayed:

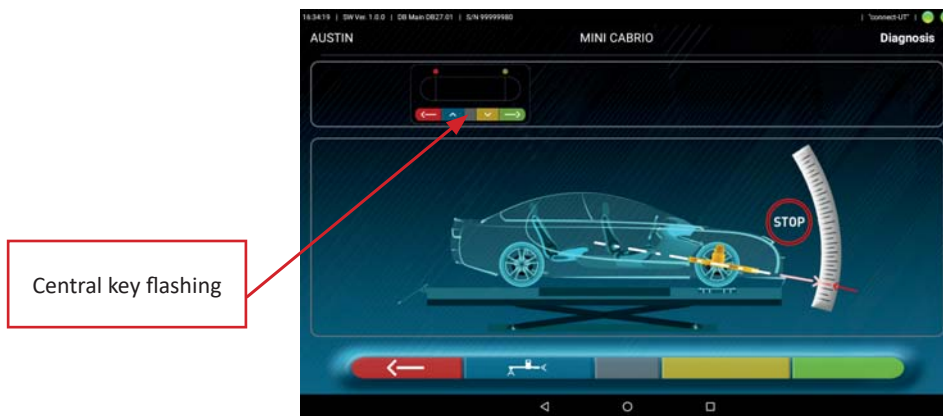

- Figure 79 -

In - Figure 79- the central key of the detector keypad flashes to indicate that it must be pressed again to

continue the procedure. By pressing the central key, the symbol  remains displayed for a few seconds at the centre of the page, during the acquisition of the angle measurement.

Then, after the acquisition, the screen showing alignment and levelling operations on detectors will appear again (See par. 6.7 on page 30):

It will be necessary to level the front detectors again; since it is no longer necessary to perform the measurement with the alignment transducers on the end of the arm (it is acquired with the Spoiler program) the program automatically moves to the next step (steering procedure de braquage See par. 6.8 on page 31).

8 ERROR SIGNALLING

During data transmission/reception between detectors and Tablet, or during angle measurement (e.g. during adjustment) a “Warning” symbol “” may appear to indicate an error condition; See- Figure 80.

Click on the “Warning” icon to view the detail of the error detected

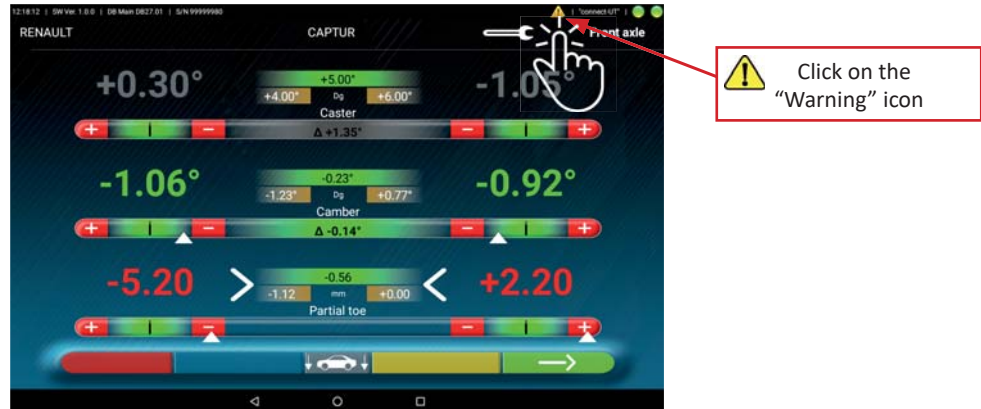

- Figure 80 -

Deux types d’erreurs peuvent être mis en évidence :

Errors of data transmission/reception between detectors -See chap. 8.1

Angle measurement errors in the horizontal plane -See Chap. 8.2

In addition, it is possible that a “low battery” condition is signalled - See Chap. 3.6.3

8.1 Data transmission error between detectors

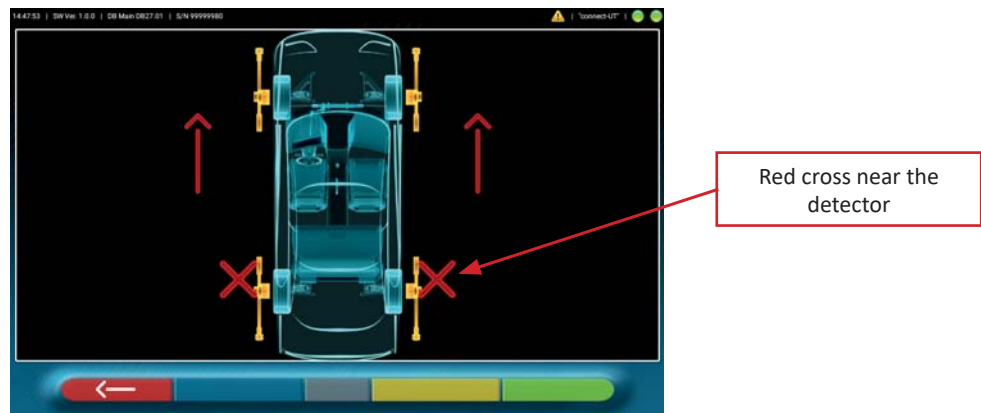

- Figure 81 -

This indicates that there is a transmission/reception failure due to one or more of the following problems:

- The infrared transceivers on the detectors are not working.
- There is a fault or interference in the transmission system.
- There is an obstacle (e.g. open vehicle door) between the front and rear detectors.

Note: The rear detectors do not communicate directly with the tablet: their data are transmitted/received through the front detectors, so in case a front detector is not working properly, it would be impossible to transmit the data of the corresponding rear detector, even if it was working.

If you remove the cause of the malfunction (i.e. the vehicle door is closed) the error page disappears immediately and the measurement page appears again on the tablet. If the problem persists it is necessary to check the hardware by contacting the technical support service.

8.2 Angle measurement error in the horizontal plane

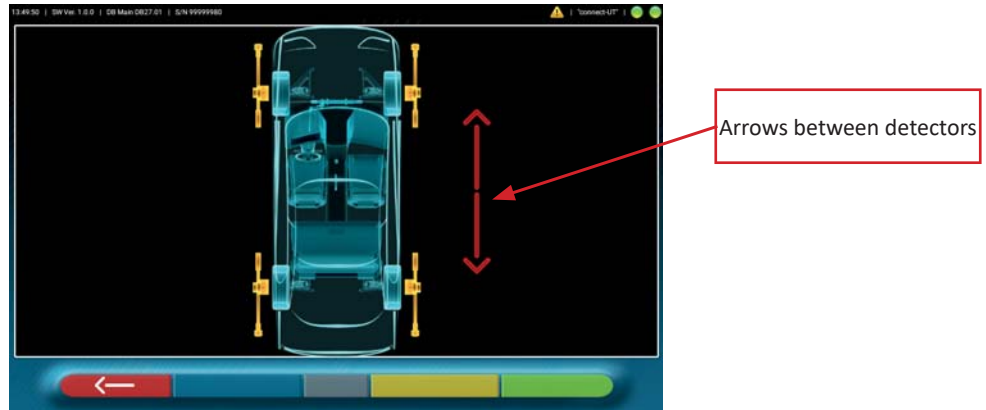

- Figure 82 -

This error page indicates that one or more infrared measurements in the horizontal plane cannot be made. Possible causes include:

- One or more CCD sensors (digital transducer for measuring angles in the horizontal plane) do not work.
- One or more infrared light emitters for measuring angles in the horizontal plane do not work (I.R. LED).
- There is an obstacle between the front and rear detectors.

If you remove the cause of the malfunction, the error page disappears immediately and the measurement page appears again on the monitor. If the problem persists it is necessary to check the hardware by contacting the technical support service.

9 PROBLEMS



Some possible problems of wheel alignment equipment are listed below.

Ravaglioli S.p.A. declines all responsibility for problems due to animals and things, for the intervention of unauthorised personnel and for the use of non-original spare parts.

Before performing any work on the system, the power supply must be switched off.

In case of doubt do not interpret, please contact Ravaglioli S.p.A. technical assistance in advance in order to receive instructions on how to carry out operations in conditions of maximum safety.

| INCONVENIENT | CAUSE | SOLUTION |
|--|---|---|
| Detectors do not turn on | - Battery fully discharged | - Recharge battery |
| Detectors are not recharged on the stands | - Mains power failure - Protection fuses interrupted | - Check mains voltage - Check protection fuses |
| Detectors do not communicate with the Tablet | - Mains power failure - Protection fuses interrupted - Access Point disconnected from the network - Tablet not connected to the WiFi network | - Check mains voltage - Check protection fuses - Connect Access Point to the network - Connect the tablet to the Wi-Fi network |

10 MAINTENANCE



WARNING! Before carrying out any maintenance work it is necessary to disconnect the machine from the mains by switching off the general power supply.

To clean plastic panels or shelves use neutral detergents (AVOID LIQUIDS CONTAINING SOLVENTS IN ANY CASE). The detectors can be cleaned with a damp cloth, then dried. Do not spray liquids directly onto the detectors and avoid cleaning with strong jets of compressed air.

Keep the optical unit filters clean using a freshly damp cloth, do not use solvents; Cleaning and other Tablet maintenance operations are described in the manual supplied with the Tablet. Always refer to the latter before performing any maintenance work on the Tablet.

11 DECOMMISSIONING AND SCRAPPING



Decommissioning - In the event of long-term decommissioning, it is necessary to disconnect the power sources and batteries of the detectors and provide for the protection of the detector optical units that could deteriorate due to excessive dust deposit.

Scrapping - When you decide to stop using this equipment, it is recommended to make it inoperative: It is recommended to make sure that parts that could pose risks are made harmless. Evaluate the classification of the good according to the degree of disposal. Scrap as scrap iron and deliver in designated collection centres. If considered special waste, disassemble and divide into homogeneous parts, then dispose of according to the laws in force.



In order to inform users on how to dispose of batteries and accumulators correctly, the following shall be communicated: The meaning of the crossed-out wheeled bin symbol on the accumulator indicates that the product must not be thrown in undifferentiated rubbish (i.e. together with "mixed municipal waste"), but must be handled separately, in order to be subjected to appropriate operations for its reuse or treatment, to remove

and safely dispose of any substances that are hazardous to the environment and extract and recycle raw materials that can be reused. For more detailed information on the end-of-life management of batteries and accumulators, please consult the After-sales Service.

12 MACHINE IDENTIFICATION DATA

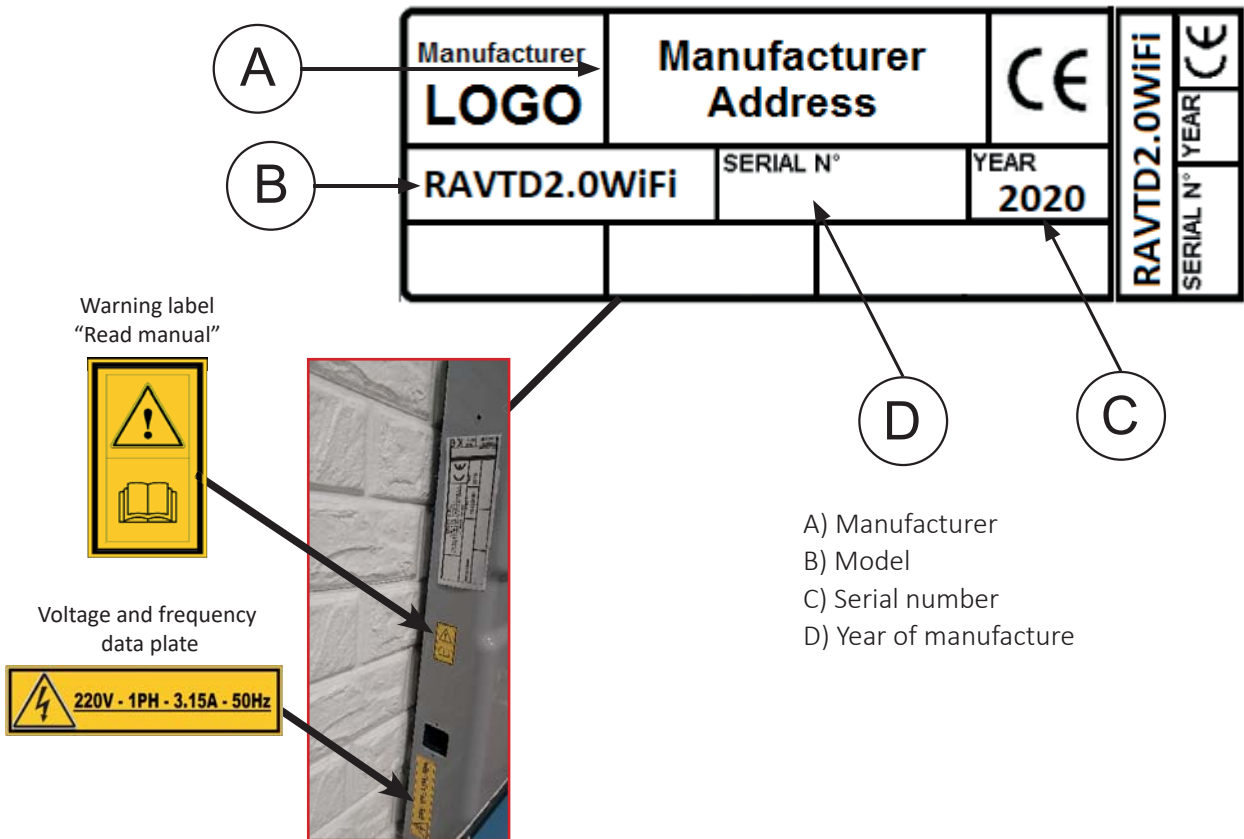

WARNING: It is absolutely forbidden to tamper with, engrave, alter in any way or even remove the identification plates of the machine; do not cover with temporary panels etc. as they must always be clearly visible.

Always keep these plates clean of grease or dirt in general.

WARNING: If for accidental reasons the identification plates are damaged (detached from the machine, damaged or even partially illegible), notify the manufacturer immediately.