

The Universal Lift for Future EVolution

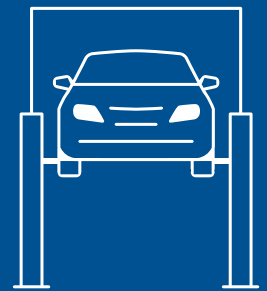

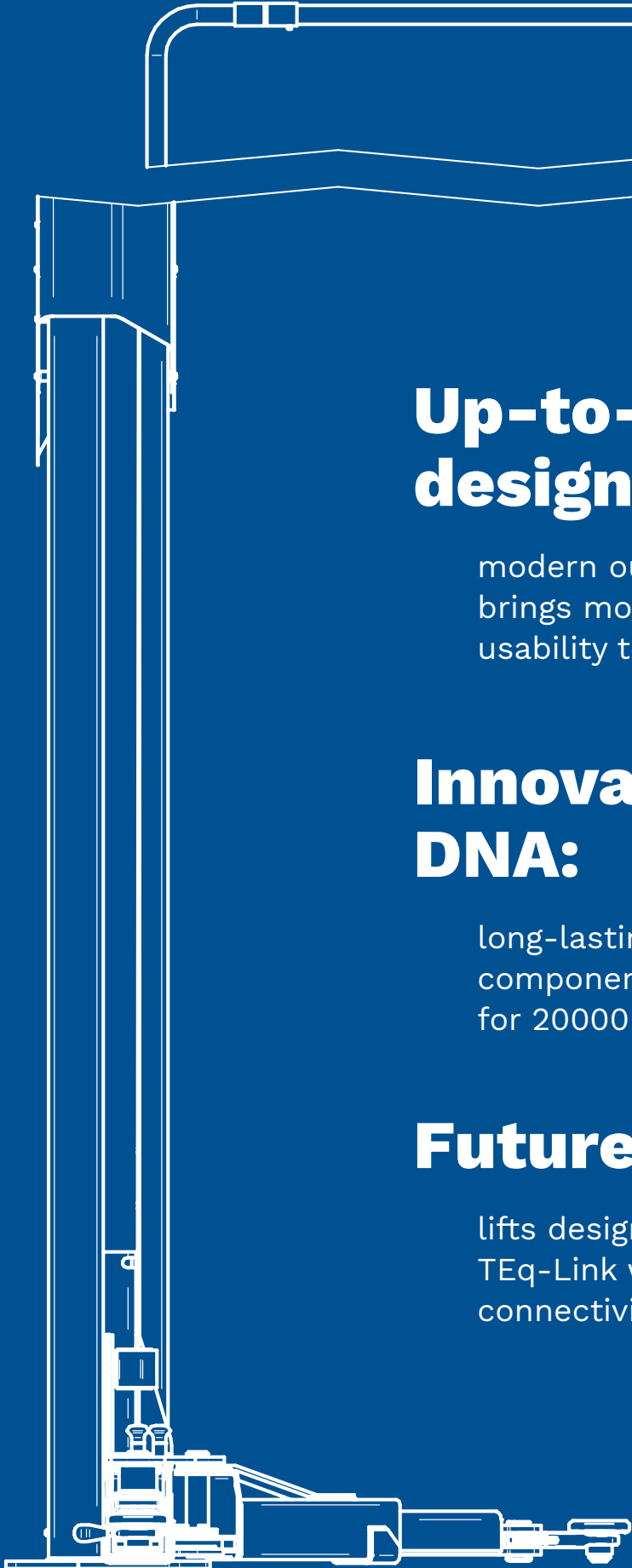

Up-to-date design:

modern outline that brings modernity and usability to the workshop

Innovative DNA:

long-lasting high-quality components and tested for 20000 cycles

Future proof:

lifts designed for the TEq-Link workshop connectivity system

Emerging from the best selling 2-post lifts, the **Legend Series** consolidates the **engineering knowledge** of Ravaglioli and shapes it into an **innovative package. Looking towards the future while always honouring the past**, Ravaglioli has set an important goal for itself - let the performance meet the design.



The innovative low-profile arms with rotating terminal

offer high flexibility of use, making the lift suitable for lifting all types of vehicles.

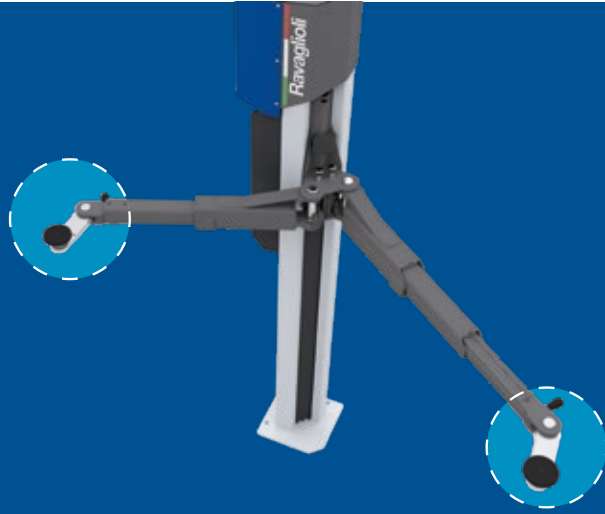

Wide lifting range.

From the classic city cars to sports cars and long wheelbase vans.

Capacity



3.5

Smart and flexible installation.

Up to 20% improvement in installation time.

The electronic synchronization avoids the installation and adjustment of the realignment cable. The lifts can be installed in a flexible way thanks to three width-adjustable positions.



Combined with a KT Series lifting table

that, due to structural reasons, can be assembled and disassembled only from the bottom of the vehicle.



Perfect for electric vehicles.

The movement flexibility of the arms provides direct access to the battery pack for its removal operations.

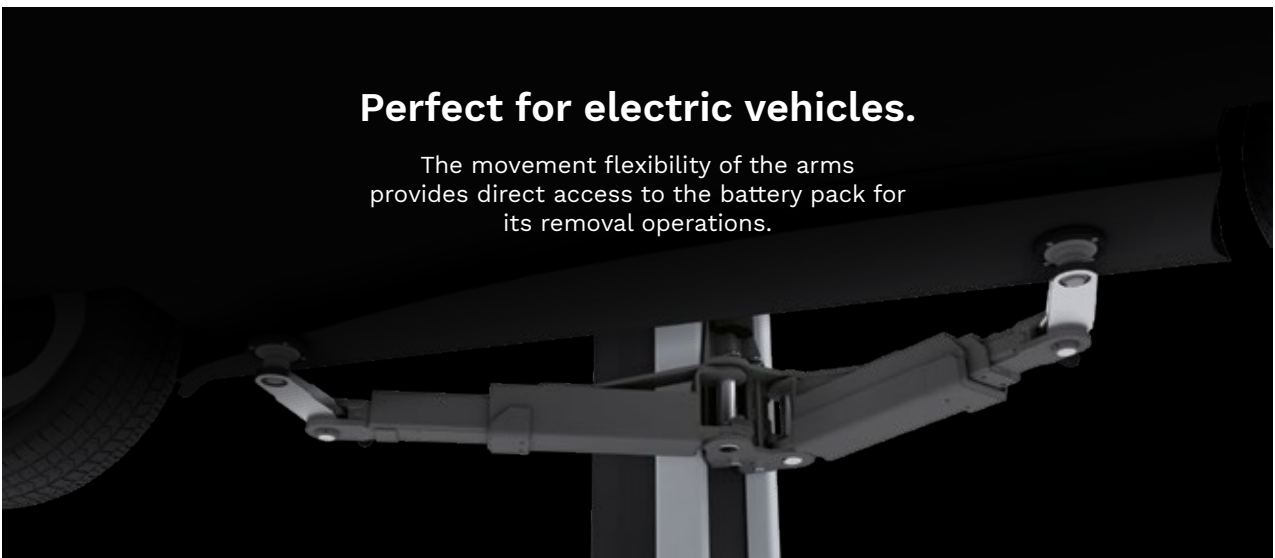

Ideal for sports cars with low profile.

The rotating terminal makes it possible to easily reach the pick-up points keeping the arm body safely away from the vehicle chassis; in this way, contacts between vehicle and lifting arms are avoided.



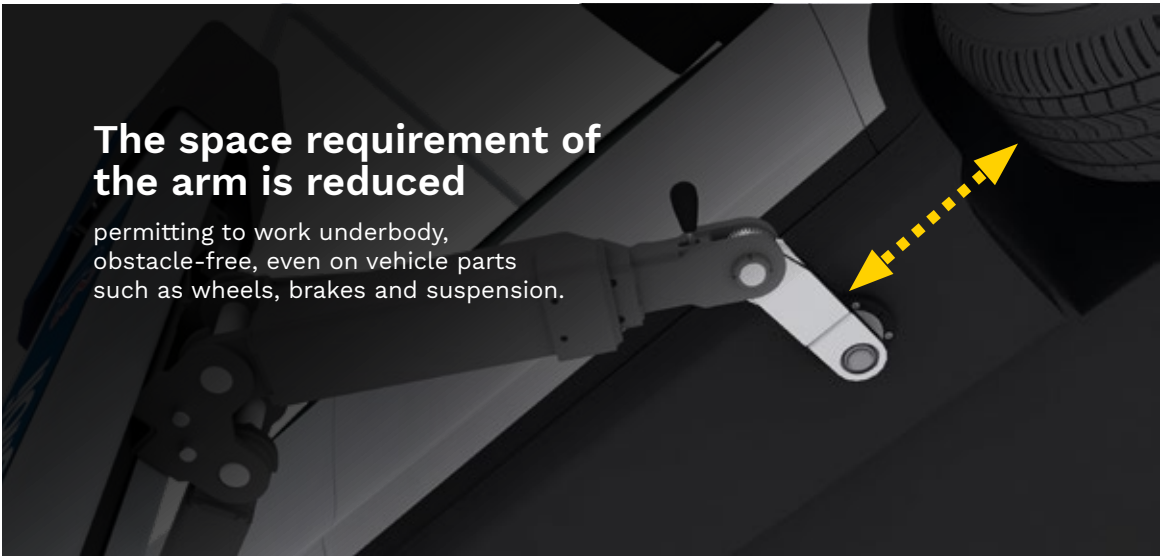

The rotating terminal is easy to adjust based on the type of vehicle.



Use in standard mode.



Use in tilted up to 90° mode.

2-POST LIFTS

Electromechanical



The perfect solution for whoever wants to set up a universal working bay.



High-strength and long-lasting materials.

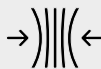

Compact design that allows space to be optimised.



Innovative geometry of the symmetric arms with rotating terminal. (Patent pending)



EEV version equipped with double control panel and energy kit.

The movement of the carriage is ensured by a rolled steel screw and a bronze nut with automatic lubrication.

Technical Data

KPX35EV

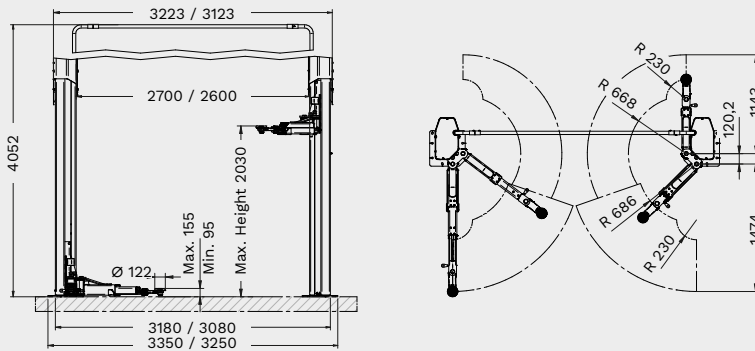

	KPX35EV
Capacity	3500 kg
Max. lifting height	2030 mm
Lifting time	42 s
Min. pad height	95 mm
Max. pad height	155 mm
Drive-through width	2472 - 2372 mm
Min. ceiling height	4150 mm
Arm layout	asymmetric
Min. front arm length	686 mm
Max. front arm length	1143 mm
Min. rear arm length	668 mm
Max. rear arm length	1474 mm
Width	3350 - 3250 mm
Height	4052 mm

	Item no.	Control	Double control panel + Energy kit	TEq-Link	Power supply
KPX35EV	RAV.KPX35.199393	push buttons		✓	400/3/50 Hz
KPX35EV (230/3/50Hz)	RAV.KPX35.199072	push buttons		✓	230/3/50 Hz
KPX35EEV	RAV.KPX35.198891	push buttons	✓	✓	400/3/50 Hz

Accessories



VSG.2CALL.901071
Kit containing 8 spacers for pads
4 spacers x H 89 mm + 4 spacers
x H 127 mm, 2 spacer support
brackets



VSG.2CALL.901248
Kit containing 4 spacers for pads
4 spacers x H 200 mm, 2 spacer
support brackets



VSG.2CALL.901163
Kit with frame engaging adapters
1 set with 4 pieces



VSG.2CALL.901330
Kit with U-shaped frame engaging
adapters
1 set with 4 pieces



VSG.2CALL.901538
Kit with pads for TESLA vehicles
1 set with 4 pads



VSG.2CALL.901859
Mercedes G class support pads kit
1 set of 4 pads



VSG.2CALL.902023
Kit with pads for Fiat 500E,
500 ABARTH
1 set with 4 pads



VSG.2CALL.902146
Kit with pads for MEB platform
1 set with 4 pads



VSG.2CALL.901378
Outrigger plates kit (3.5 t)
1 set of 2 plates, allowing
installation on floors with poor
capacity or lower concrete
thickness



VSG.2CELM.902344
Kit for increasing overhead cable
passage height
Up to + 1.5 m



VSG.2CELM.901927
Eyebolt for handling columns
(3.2 t - 3.5 t - 4.2 t)
It facilitates installation of the
lift, can be used again for other
installations



VSG.2CALL.902818
Vehicles lift platforms kit
1 set with 4 ramps, ramp height 60
mm

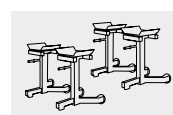

VSG.2CALL.902085
Kit of stands for alignment
1 set with 4 stands



VSG.2CALL.902641
Magnetic tray
1 set with 2 trays



VSG.2CALL.902511
Holder for impact wrench
Ergonomic tool support



RAV Italy

Vehicle Service Group Italy S.r.l.

Via Filippo Brunelleschi 9
44020 Ostellato (FE)
Italy

☎ +39.051.6781511
☎ +39.051.846349
✉ rav@ravaglioli.com

RAV France

RAV France SARL

4, Rue De La Longue Raie
ZAC de la Tremblaie
91220 Le Plessis Pâté
France

☎ +33.1.60.86.88.16
☎ +33.1.60.86.82.04
✉ rav@ravfrance.fr

RAV Germany

BlitzRotary GmbH

Hüfänger Straße 55
78199 Bräunlingen
Germany

☎ +49.771.9233.0
☎ +49.771.9233.99
✉ ravid@ravaglioli.com

RAV UK

Vehicle Service Group UK Ltd

3 Fourth Avenue,
Bluebridge Industrial Estate
Halstead, Essex, CO9 2SY
United Kingdom

☎ +44.1787.477711
☎ +44.1787.477720
✉ rav@ravaglioli.com

DRD39U(02)

Technical data and composition presented in this catalogue may vary.
Pictures reproduced are only indicative.
Photo credits: Technik Auto Service - Autoquip Garage Equipment / Brands Hatch

Member of VSG - Vehicle Service Group
a **DOVER** company

